

#BONGIOOFFICIAL



EMO
TIONAL
2019

bongio
MADE IN ITALY SINCE 1936

#BONGIOOFFICIAL

“

L'AUTENTICA CREATIVITÀ
NEL DESIGN
UNISCE ECCELLENZA FUNZIONALE,
INNOVAZIONE TECNOLOGICA
E CURA ARTIGIANALE DEL DETTAGLIO.
UN PRODOTTO BONGIO
È BELLO PERCHÉ INNOVATIVO
E INNOVATIVO PERCHÉ BELLO.

Real design creativity brings together functional excellence,
technological innovation and an artisanal flair for detail.
A Bongio product is appealing because it is innovative
and innovative because it is appealing.

”

Antonio Bongio

#COLLECTIONS2019

bongio
MADE IN ITALY SINCE 1936

DINAMICA DELLA CREATIVITÀ

Creativity dynamics

Dinamica della Creatività non è uno slogan, ma una visione del mondo dove pensiero, cultura, territorio e Made in Italy si integrano nell'energia creativa che da ottant'anni alimenta la nostra storia con nuove sfide, nuovi obiettivi, nuovi traguardi, da raggiungere assieme a chi ci sceglie.

#PASSIONECREATIVA

Crediamo nella bellezza del lavoro fatto bene, nella cura del dettaglio, nel coraggio di guardare oltre e di svegliarsi tutte le mattine con un'idea nuova in testa. Ci piace innovare per migliorare sempre i nostri prodotti e unire forma e contenuto in una sintesi perfetta di design e funzionalità.

#DNABONGIO

La nostra missione è produrre rubinetterie e sistemi completi per il bagno e gli ambienti dove l'acqua è protagonista. Vogliamo che i nostri prodotti siano in grado di testimoniare da soli il DNA autentico di Bongio, basato su valori incrollabili di creatività, bellezza, funzionalità, qualità, innovazione.

Creativity Dynamics is not a slogan, it is the way we see the world where thought, culture, local excellence and Made in Italy design mingle with the creative energy that has driven our history for eighty years now, animating it with new challenges, new goals and new milestones shared with all those along our pathway.

#CREATIVEPASSION

We believe in the beauty of a job well done, the importance of taking care of every little detail, the courage to look beyond the here and now and the value of waking up every morning with a new idea in mind. The way we see it, innovation is the best way to ensure the constant improvement of our products, working with form and content so that design meets functionality.

#DNABONGIO

It is our mission to produce total look or wellness systems for the bathroom and other environments where water reigns supreme. We want our products to speak on our behalf and convey Bongio's very essence which rests on the unshakable values of creativity, beauty, functionality, quality and innovation.



#CHANGE PERSPECTIVE





UN FUTURO CHE VIENE DA LONTANO

*A future coming from
far behind*

Bongio nasce dall'intuizione del suo fondatore Mario Bongio, che nel 1936 apre una piccola manifattura ad Alzo di Pella, sulle rive del lago d'Orta. Da subito l'azienda sceglie la strada dell'innovazione, della qualità e del design che ne hanno costituito il DNA creativo in grado di coniugare funzionalità, stile, tecnologia e cura artigianale del dettaglio.

Fedele allo spirito del suo fondatore, Bongio si è evoluta sotto la guida del figlio Antonio Bongio fino a diventare nel tempo un marchio di punta del Made in Italy nel mondo, con prodotti iconici e centinaia di realizzazioni di prestigio.

Bongio was born from the intuition of its founder, Mario Bongio, who in 1936 opened a small manufacturing business in Alzo di Pella on the shores of Lake Orta. From its very onset, the company chooses to pursue a path of innovation, quality and design that have formed its creative DNA, combining functionality, style, technology and a handcrafted care for details.

True to the spirit of its founder, Bongio has evolved under the management of his son, Antonio Bongio, to the point of becoming a signature brand of Made in Italy in the world, manufacturing iconic products and developing hundreds of prestigious projects.



LA MATERIA DELLE IDEE

The substance of ideas

INNOVATIVO SAPERE ARTIGIANALE

Ogni prodotto Bongio nasce dall'innovazione funzionale, che attraverso la risoluzione di problemi ergonomici, dinamici, energetici, ecosostenibili e soprattutto di ingegneria dei materiali e di utilizzo pratico, arrivi all'eccellenza della forma e del design attraverso un consolidato sapere artigianale.

MADE IN ITALY #MADE IN BONGIO

Made in Italy per noi significa "Made in Bongio", ossia un processo produttivo di eccellenza che comprende:

- processo integrato interno
- cura del dettaglio
- rispetto dei codici etici del lavoro
- certificazioni di prodotto e processo
- certificazioni sui componenti
- verniciatura interna e processi galvanici

10 ANNI DI GARANZIA

Controlliamo tutti i rubinetti e tutti gli accessori in fasi diverse della catena di produzione e un attestato di avvenuto controllo è inserito in ogni confezione. Le nostre operatrici controllano anche le superfici nei minimi particolari per garantire uniformità e perfezione estetica a ogni pezzo. Per questo possiamo offrire 10 anni di garanzia su ogni articolo.

GROUND-BREAKING ARTISANAL SKILLS

Each Bongio product is based on the concept of functional innovation. By getting to the heart of ergonomic, dynamic, energy and sustainability issues, but especially by focusing on materials engineering and practical ramifications, superb results in terms of form and design can be achieved when you are able to rely on pure artisanal expertise.

MADE IN ITALY #MADE IN BONGIO

For us, Made in Italy means "Made in Bongio" and our outstanding production process includes:

- an integrated internal process
- meticulous detailing
- observance of a code of ethics on the workplace
- product and process certifications
- component certifications
- internal coatings and galvanic process

A 10-YEAR GUARANTEE

All faucets and accessories are checked at various stages of the production chain and an inspection certificate is placed inside each package. Our operators also run thorough surface checks to make sure that each and every piece is aesthetically perfect, smooth and even. This allows us to offer a 10-year guarantee on all items.



bongio

#10YEARSWARRANTY

IL DESIGN COME MODO DI ESSERE

Design for design's sake

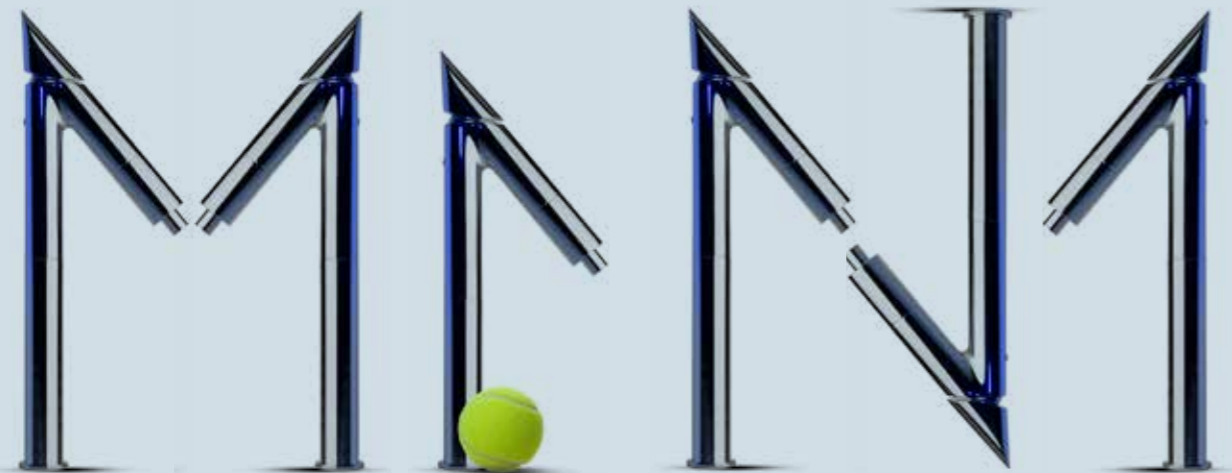

In Bongio la forma è la sostanza e la sostanza è la forma. Il design è un modo di essere che pervade ogni ambito del nostro operare quotidiano. Ricerchiamo e progettiamo soluzioni sempre innovative, che coniughino bellezza e funzionalità come tipica espressione di creatività italiana.

TOTAL LOOK BONGIO

Abbiamo lavorato con professionisti e artisti che condividono con noi l'idea del bagno come total look per rendere l'acqua elemento vitalizzante dell'abitare sia indoor sia outdoor.

At Bongio, form is substance and substance is form. Design pervades our very being and all our daily pursuits. We constantly seek out and design innovative solutions in order to achieve that functional beauty that is so typical of Italian creations.

TOTAL LOOK BONGIO

We have worked with professional experts and artists who share our enthusiasm for a TOTAL LOOK for the bathroom, tapping into the rejuvenating power of water for indoor and outdoor environments.

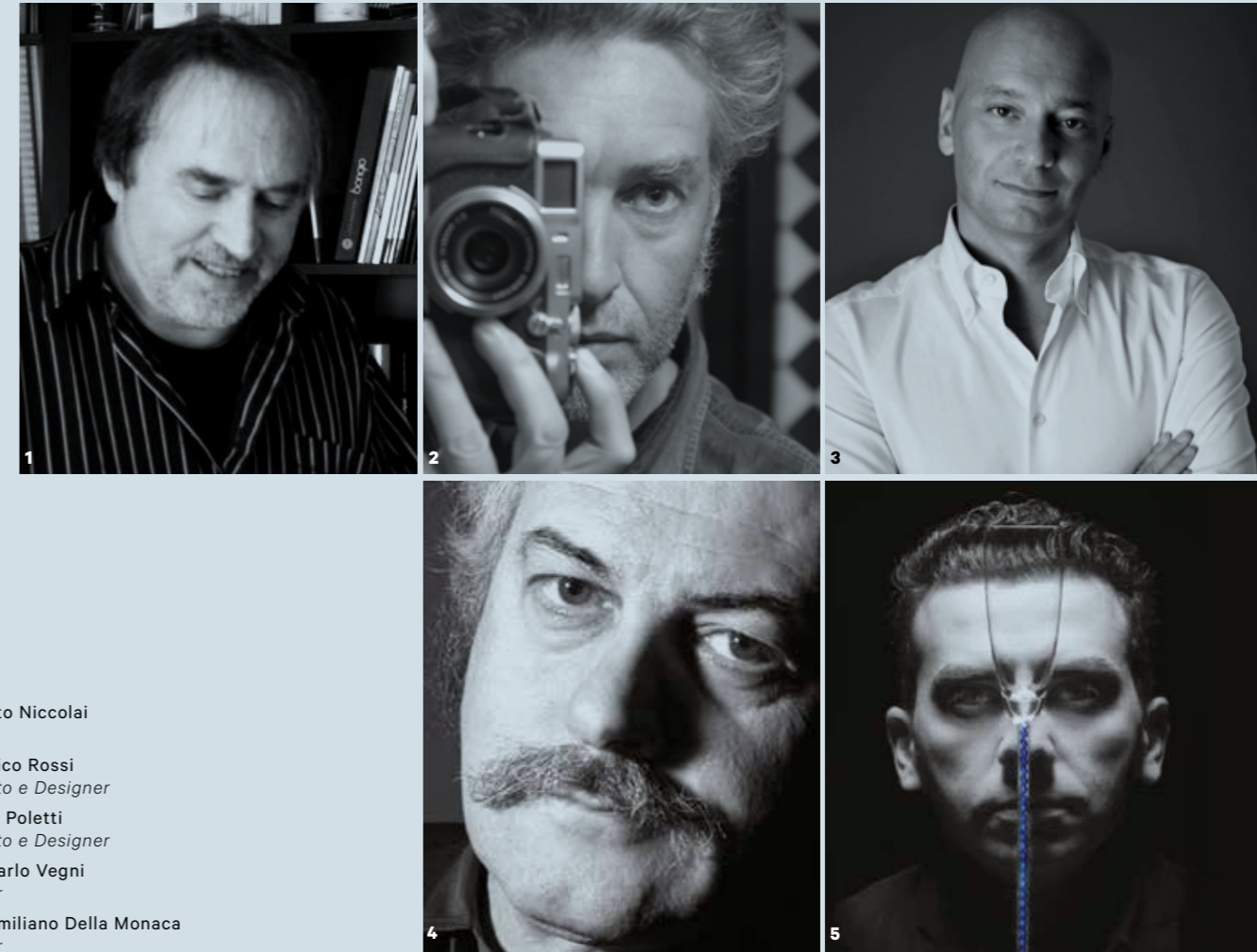

1. Roberto Niccolai
Creativo
2. Federico Rossi
Architetto e Designer
3. Marco Poletti
Architetto e Designer
4. Giancarlo Vegni
Designer
5. Massimiliano Della Monaca
Designer

LA COLLABORAZIONE
CON I DESIGNER
È LA CONVERGENZA NATURALE
DI UN SENTIRE COMUNE.

*Collaboration with designers
is natural convergence of a common feeling.*

INFINITE FINITURE

Countless finishes

L'ampia gamma di finiture e i processi di trattamento galvanico sono i fiori all'occhiello della nostra tecnologia che conferiscono resistenza e brillantezza a ogni pezzo grazie ai collaudati sistemi semi-automatici per un controllo degli spessori pezzo per pezzo e componente per componente.

DORATURA PERFETTA

Da oltre vent'anni la nostra formula di doratura è realizzata con una esclusiva lega d'oro 24 carati, la cui applicazione consente di raggiungere uno spessore tre volte superiore rispetto alle dorature standard e non richiede ulteriori verniciature protettive. Il risultato, oltre a un aumento della resistenza meccanica agli urti, è una maggiore luminosità del pezzo, davvero brillante come oro puro.

CROMATURA DI SPESSORE E VERNICIATURA A POLVERE EPOSSIPOLIESTERE

In Bongio abbiamo collaudato un esclusivo sistema manuale che consente una permanenza nel bagno galvanico adeguata all'effetto che si vuole ottenere. Da ciò deriva uno spessore di cromatura più alto rispetto a quello ottenibile con il procedimento automatico, con i conseguenti vantaggi di durata, luminosità e resistenza e applicabilità in ogni condizione climatica o geografica.

We offer a wide range of finishes and galvanic-treatment processes and, out of all our technological achievements, these are our pride and joy. Time-tested semi-automatic systems check every single piece and component for thickness, ensuring the strength and brightness of each single item.

PERFECT GOLD

For more than twenty years, our gilding process has been carried out with an exclusive 24-karat gold alloy, allowing us to achieve three times the thickness of standard gilding and, what is more, it does not need any additional protective coatings. As well as making it more resistant to knocks, it also gives the items extraordinary luminosity - they gleam just like pure gold.

THICK CHROME-PLATING AND EPOXY-POLYESTER POWDER COATING







At Bongio, we use an exclusive tried-and-tested manual system which allows us to leave items in the electroplating bath as long as is necessary to achieve the desired effect. The chrome-plated surface is denser compared to automatically-processed products, leading to huge benefits in terms of lifespan, luminosity, durability, resistance and high performance regardless of climate or geographic location.



FINITURE E COLORI / FINISHES AND COLOURS

 AS Acciaio Spazzolato 316 316 Brushed Stainless Steel	 CR Cromo Chrome	 CN Cromo Nero* Black Chrome*	 PL Platinum	 NS Nichel Spazzolato Brushed Nickel
 NI Nichel Lucido Light Nickel	 BR Bronzo Bronze	 AG Argento Antico Old Silver	 FA Ferro Antico Old Iron	 TT Terra di Toscana Tuscany
 RA Rame Antico Old Copper	 ON Ottone Naturale Natural Brass	 BU Ottone Burattato Burattato	 RB Moka Matt Moka	 CO Cromo + Oro Chrome + Gold
 OR Oro Gold	 OP Oro Spazzolato Brushed Gold	 OA Oro Rosa** Rose Gold**		
 BI Bianco Opaco Matt White	 NE Nero Opaco Matt Black (RAL 9005)	 SB Fragola Strawberry (RAL 4010)	 LI Lime	 SS Supersky (RAL 5015)
 RS Rosso F1 F1 Red (RAL 3000)				

SWITCH20

 NEME Nero Opaco + Verde Matt Black + Green	 NENE Nero Opaco + Nero Matt Black + Black	 SIME Silver + Verde Silver + Green	 SINE Silver + Nero Silver + Black	 NERS Nero Opaco + Rosso Matt Black + Red
 SIRS Silver + Rosso Silver + Red				

* Disponibile anche Cromo Nero Spazzolato / Available Brushed Black Chrome
** Disponibile anche Oro Rosa Spazzolato / Available Brushed Rose Gold

PURE GLAM: FINITURE CON SWAROVSKY® / MADE WITH SWAROVSKY®

 CR01 Cromo + Swarovski Trasparente / Chrome + Transparent Swarovski	 CR02 Cromo + Swarovski Nero / Chrome + Black Swarovski	 OR01 Oro+ Swarovski trasparente / Gold + Transparent Swarovski	 OR02 Oro+ Swarovski Nero / Gold + Black Swarovski	 NE01 Nero+ Swarovski trasparente / Black + Transparent Swarovski
 NE02 Nero + Swarovski nero Black + Black Swarovski				

SOFFI / MYAMIX CRYSTAL: FINITURE IN VETRO DI MURANO / FINISHES MURANO GLASS

 77 Bianco + Foglia Oro White + Golden Leaf	 44 Bianco White	 88 Bianco + 3 Cannette Nere / White + 3 Black Lines	 AG Sfera Trasparente + Foglia Argento (per maniglia) Transparent Sphere + Silver Leaf (for handle)	 OR Sfera Trasparente + Foglia Oro (per maniglia) Transparent Sphere + Golden Leaf (for handle)
--	---	--	--	--

AQUA: MANIGLIE IN MARMO CALACATTA E PORTORO / CALACATTA AND PORTORO MARBLE HANDLES

 CRPO Cromo + Marmo Portoro Chrome + Portoro Marble	 CRKA Cromo + Marmo Calacatta Chrome + Calacatta Marble	 CNKA Cromo Nero + Marmo Calacatta Black Chrome + Calacatta Marble	 ORPO Oro + Marmo Portoro Gold + Portoro Marble
--	--	---	--

SEZIONE CLASSIC: COLORI MANIGLIE / CLASSIC SECTION: HANDLES COLOURS

 00 Bianco White	 03 Lilla Lilac	 04 Turchese Turquoise	 05 Ciliegia Rossa Cherry Red	 06 Rosa Antico Antique Pink
 07 Smeraldo Emerald	 08 Blu Reale Royal Blue	 09 Rubino Ruby	 0L Porcellana Bianca White Porcelain	 NU Porcellana Nera Black Porcelain
 CI Cromo Chrome	 ZE Swarovski Trasparente Transparent Swarovski	 PO Marmo Portoro Portoro Marble		

CR - CROMO

È la finitura più utilizzata, con superfici a specchio e grazie agli spessori elevati, risulta anche la più resistente.

NI - NICHEL LUCIDO

Finitura simile al cromo ma dalle tonalità più calde. Inizialmente le superfici risultano a specchio, ma con il tempo si ossidano passando ad una tonalità simile all'argento.

NS - NICHEL SPAZZOLATO

Finitura spazzolata della versione lucida. Può ricordare l'acciaio inox ma con una tonalità più calda. Ideale utilizzata sia per serie classiche che moderne.

PL - PLATINUM

Finitura galvanica cromata ottenuta con una spazzolatura manuale. L'effetto ricorda l'acciaio spazzolato.

ON - OTTONE NATURALE

Finitura naturale che con il tempo, a contatto con l'atmosfera, cambia la tonalità divenendo di colore più scuro sulle superfici di minor contatto.

BU - OTTONE BURATTATO

Finitura grezza (non lucidata) con effetto semi martellato.

OR - ORO

Finitura galvanica che si ottiene in bagni elettrolitici di oro 24 kt.

OA - ORO ROSA

Finitura galvanica che si ottiene in bagni elettrolitici di oro rosa 22 kt che contengono una piccolissima percentuale di rame che conferisce il caratteristico colore rosato, finitura ideale per serie classiche e moderne. Disponibile anche Oro Rosa Spazzolato.

OP - ORO SPAZZOLATO

Finitura galvanica ottenuta in bagni elettrolitici di oro 24 kt con spazzolatura manuale. Ideale per serie moderne.

TT - TERRA DI TOSCANA

Finitura galvanica ottenuta in più fasi compresa una spazzolatura manuale ed una particolare pulitura con creme lucidanti, effettuata a mano per dare il caratteristico effetto invecchiato. Questa finitura si ossida con il tempo lasciando più chiare le zone di maggior contatto. Questa finitura viene realizzata con trattamenti manuali e data la particolare lavorazione artigianale può presentare una colorazione non uniforme.

FA - FERRO ANTICO

Finitura galvanica ottenuta depositando vari strati metallici di diverse finiture, su cui si effettua una spazzolatura manuale e viene applicata una vernice satinata per mantenere inalterato il caratteristico effetto invecchiato. Ideale per serie classiche e moderne.

NE - NERO OPACO

Finitura in vernice opaca a spessore in polvere. Ideale per serie moderne. Questa finitura viene realizzata con trattamenti manuali e data la particolare lavorazione artigianale può presentare una colorazione non uniforme.

RB - MOKA

Finitura in vernice opaca a spessore in polvere, dall'intensa tonalità marrone scuro.

BI - BIANCO OPACO

Finitura in vernice opaca a spessore in polvere. Ideale per serie moderne.

RS-SS-SB-LI

(ROSSO F1 / SUPERSKY / FRAGOLA / LIME)
Sono finiture in vernice lucida, tonalità molto allegre ideali per serie moderne.

RA - RAME ANTICO

Finitura galvanica ottenuta grazie ad una spazzolatura manuale che esalta i riflessi metallici delle varie tonalità del rame ed infine protetta da una vernice trasparente che ne preserva le caratteristiche.

BR - BRONZO

Finitura galvanica ottenuta grazie ad una spazzolatura manuale per esaltare i riflessi metallici chiari e scuri e protetta da una vernice trasparente che ne preserva le caratteristiche. Ideale per serie classiche.

AG - ARGENTO ANTICO

Finitura galvanica ottenuta grazie ad una spazzolatura manuale e protetta da una vernice trasparente che ne preserva le caratteristiche. Finitura simile al peltro, ideale per serie classiche.

AS - ACCIAIO SPAZZOLATO

L'acciaio inox combina i vantaggi di un materiale estremamente igienico, per una garanzia di lunga durata.

CN - CROMO NERO

Finitura simile al cromo, ma dalla tonalità più fredda. Superficie a specchio, resistente, con bagliori simili alla "pietra onice". Disponibile anche Cromo Nero Spazzolato.

CR - CHROME

It is the most required finish with a mirror surface. Our higher thickness of chrome grants higher resistance.

NI - LIGHT NICKEL

Finish very similar to the chrome but more warm. At the beginning you have a mirror-yellow surface. Then the time and the air change to a silver tonality.

NS - BRUSHED NICKEL

Brushed finish of the am glossy one. It is similar to the platinum but more warm. This could be ideal for both modern and classical collections.

PL - PLATINUM

Brushed chromed galvanic finish, obtained through a manual brushing, with the final effect of the brushed stainless steel.

ON - NATURAL BRASS

Natural finish of the raw brass that during the time and in contact with the air, it will change the tonality, becoming more dark over the surfaces of less contact.

BU - BURATTATO

Raw finish (not polished) with hammered effect of the brass.

OR - GOLD

Galvanic finish obtained by 24 kt gold electrolytic processing.

OA - ROSE GOLD

Galvanic finish obtained by 22 kt gold electrolytic processing. That contain a smallest quantity of copper that gives the characteristic rosed color, ideal finish for classic and modern series. Available Brushed Rose Gold.

OP - BRUSHED GOLD

Manual brushing made on the am gold finish. This has suggested for the modern collections.

TT - TUSCANY

Galvanic finish obtained through more phases, from a manual brushing to a particular polishing. Using a special glossy cream, we obtain the effect of an old finish. This finish could oxidized in the time over the parts of most contacts.

This finish is made with manual treatments and may therefore display colours variations due to the particular craftsmanship.

FA - OLD IRON

Galvanic finish obtained by the deposit of different metallic finish, one over the other, plus a manual brushing and a final application of a mat varnish to maintain the old 'effect' during the time. This finish it is the best for the classic and modern collections.

NE - MATT BLACK

Matt black tonality finishing obtained by powder. This finish is made with manual treatments and may therefore display colours variations due to the particular craftsmanship.

RB - MATT MOKA

Deep dark brown tonality for this finish obtained by powder and then covered by a matt paint.

BI - MATT WHITE

Matt white tonality finishing obtained by powder.

RS-SS-SB-LI

(F1 RED / SUPERSKY / STRAWBERRY / LIME)
This finishes are made in gloss paint, ideal for modern series.

RA - OLD COPPER

Galvanic finish obtained through a manual brushing that evidences the metallic tonality of different kind of copper and recovered by a transparent varnish.

BR - BRONZE

Galvanic finish obtained by a manual brushing that evidences the dark and clear metallic reflections, covered then by a transparent varnish. This finish it is the best for the classic collections.

AG - OLD SILVER

Galvanic finish obtained through a manual brushing and recovered by a transparent varnish. This finish is similar to the tonality of the pewter and it has suggested for the classical collections.

AS - BRUSHED STEEL

The brushed stainless steel combines the benefits of an extremely hygienic and strong object.

CN - BLACK CHROME

This finishing very similar to the Chrome but more cold. The surface are like mirror with flosch similar to "unix stone".

Available Brushed Black Chrome.

BONGIO NEL MONDO

Bongio in the world

ALPHONSE HOTEL - SEYCHELLES
 METROPOLITAN PALACE HOTEL - DUBAI U.A.E.
 TILAL BEIRUT - LEBANON
 PALAZZO DE 3 AGOSTO MALABO - GUINEA EQUATORIALE
VILLA PROJECT OF DREAM ISLAND IN JEDDAH
TOURISTIC CITY - DOURRAT AL'ARUS
 MASAJEL DUE 45 MT YACHT (OWNER FAMILY OF MINISTER OF DEFENSE) - KUWAIT
 TEXACO OFFICES LAGOS NIGERIA (MINISTRY OF DEFENSE OFFICES) - SAUDI ARABIA
 HOTEL FORUM BEIRUT - LEBANON
 SCHLOSS POKVAR CASTLE TET - UNGARN
HOTEL SAN ROCCO ORTA - ITALY
 HOTEL PLANET CERVINIA - ITALY
 HOTEL DA EMORE C.C.C CONCREZA CARACAS - VENEZUELA
 HOTEL AL BUSTAN BEIT MERY, EL METN - LEBANON
 HOTEL BEVERLY BEACH JOUNIEH - KESEROUAN
 HOTEL SEAROCK RAOUCHE BEIRUT - LEBANON
 METROPOLITAN PALACE HOTEL BEIRUT - LEBANON
STADIUM WORLDS CUP - KOREA
 SANGJEE GANGBYUN VILLA - KOREA
 2-20A MINDEN AVENUE - CHINA
HOTEL NOVECENTO BOLOGNA - ITALY
 KUMHO YOUYEIDO RESIDENCE SEOUL - KOREA
 JUKIN APARTMENTS SEOUL - KOREA
 ALPOME 107 RESIDENCE SEOUL - KOREA
DESROCHES ISLAND LODGE - SEYCHELLES
 VILLA ASONGA BATA - GUINEA EQUATORIALE
 KUMHO YOUYEIDO PRJ - KOREA
 JUKIN APARTMENT - KOREA
 ALPOME107 PRJ - KOREA
 DAELIM ACROVIST PRJ - KOREA
 MICHELLAN 147 PRJ - KOREA
 POSCO LTD. PRJ - KOREA
FORTRESS CENTRE - HONG KONG
 AL HAMRA RESORT - DUBAI U.A.E.
 SHANGRI LA RESORT BANGKOK - THAILAND
 HILTON HOTEL - MALAYSIA
 CONDOMINIUM EVELYN ROAD - SINGAPORE
 GREEN LAKE HOTEL - CHINA
LAGOON BEACH - SOUTH AFRICA
 THE SOFA HOTEL - ISTANBUL
 KEMPINSKI - DUBAI U.A.E.
THE PALM - DUBAI U.A.E.
 KUWAIT EMBASSY (IN THE WORLD)
DOHA AIRPORT (VIP AREA)
 WEMBLEY STADIUM - UK
MANCHESTER UNITED STADIUM - UK
 RITZ CARLTON HOTEL - NEW YORK
 SOFITEL AUKLAND - NEW ZEALAND
HILTON SHENZHEN - CHINA
 CROWNE PLAZA HOTEL - DUBAI U.A.E.
AL BARARI VILLAS - DUBAI
 VICTORIA REGIA SOFITEL BOGOTÀ - COLOMBIA
SHERATON HOTEL - DOHA QATAR
 HOTEL EMPIRE - HONG KONG
 SAFFRON APARTMENT - NEW ZEALAND
 SOFITEL SHENZHEN - CHINA
 H PROJECT ORCHARD ROAD - SINGAPORE
MARINE VICEROY HOTEL YAS ISLAND - ABU DHABI (FORMULA 1 CIRCUIT)
 PARK HOTEL NAPOLI - ITALY
TRUMP TOWER - PANAMA

MEDINA ONE HOTEL - DUBAI U.A.E.
 ROJAL MIRAGE - MAROC
HILTON HOTEL BOGOTÀ - COLOMBIA
 LES DUNES DE FAQRA - LEBANON
 PRINCE QATAR DAMASCUS - SIRIA
ROYAL MIRAGE - DUBAI
 UNA HOTEL BENEVENTO - ITALY
 DALLOUL - QATAR
 ALMANA VILLA - QATAR
ST. REGIS RESORT - ABU DHABI
 DHARMAWANGSA - INDONESIA
 PRJ ANTOINE MEDLEJ HAZMIEH - LEBANON
 HOCHAR TOWER - LEBANON
 OBEROI HOTEL - MUMBAI
HOTEL GALAXY - MACAU
 SHANXI HOTEL - CHINA
 MARRIOT HOTEL - DOHA QATAR
FENDI SHOPS IN THE WORLD
ST. REGIS - ABU DHABI
VICEM BODRUM YALILARI - TURKEY
 SENTOSA PRJ - SINGAPORE
 SOFITEL HENSHAN - SHANGHAI
 EMPIRE HOTEL - HONG KONG
RITZ CARLTON JUMEIRAH - DUBAI
 8 ARDMORE PARK - SINGAPORE
 8/85 TOWER B BOGOTÀ - COLOMBIA
CANTINE ANTINORI - FIRENZE
BANANA ISLAND - DOHA QATAR
ROYAL PALACE - DOHA QATAR
 CASA CALAPURNIA - BOGOTÀ
 THE NEW SHERATON IN - DOHA QATAR
FENDI APT AT DAMAC HEIGHT - DUBAI U.A.E.
MALL OF QATAR - DOHA QATAR
SAVOY HOTEL - PRAHA
DD3 - DUBAI U.A.E.
 HILTON AL KHOBAR
CURIO HOTEL BY DOUBLE TREE HILTON - DOHA
 AL SAADYAT ISLAND VILLAS - ABU DHABI
OMAN PALACE - SULTANATE OF OMAN
LAKEVILLE RESIDENTIAL - SHANGHAI
JASSYIA PALACE - QATAR
SHK BULK RESIDENTIAL - HONG KONG
 AL KHAYATT VILLAS - QATAR
 AL REFAA VILLAS - QATAR
SALITRE 1000 - PORTUGAL
 MET. ACAPPELLA - HONG KONG
 PEARL RESTAURANT - DOHA QATAR
AL NAJADA SOUQ WAQIF BOUTIQUE HOTEL - DOHA
NEGARESTAN LUXURY COMPLEX LAVASTAN TEHERAN - IRAN
SHERATON - LAGOS NIGERIA
 RESERVA QUINTA DO LAGO - PORTUGAL
RCA MOSQUE - VIVENDA PROJECT JEDDAH OMAN
HOTEL YURBBAN PASSAGE BARCELONA
 HOTEL LES BORDS DE MER, MARSIGLIA
HOTEL CASA COOK CRETA
 NIKH HOTEL, SIYNTAGMA, ATHENS
 MEDITERRANEAN WHITE RESORT, SANTORINI ISLAND
 VIVE MAR CAFE, VOULA, ATHENS
 HOTEL P4, VARSAVIA
 HOTEL CALLIA RETREAT, SANTORINI
 QUARTANO HOTEL, PAROS ISLAND
 SANTANA BEACH BAR-RESTAURANT, MIKONOS ISLAND
 PERE UBU CAFE, GLYFADA

EMOTIONAL 2019

#BONGIOOFFICIAL

TIME 2020

DESIGN CENTER DIRECTED BY
ANTONIO BONGIO

#NATURALCHIC



1

A naturally sophisticated elegance

ESSENZIALITÀ NATURALE

Natural essence

La purezza dell'acciaio inox 316, la pulizia delle linee, la finitura micro-spazzolata e la completezza di accessori rendono TIME2020 la scelta ideale per ambienti interni ed esterni improntati all'essenzialità più sofisticata, che non rinuncia all'autenticità di un effetto naturale.

The purity of AISI 316 stainless steel and the clean lines, micro-brushed-finish and full range of accessories make TIME 2020 the ideal choice to decorate indoor and outdoor living spaces whose design is meant to evoke the most sophisticated simplicity but at the same time also capture the authenticity of a natural effect.

#DUSTY



2



#SOPHISTICATED



3

- 1. Art. 70521AS00
- 2. Art. 70131AS0D
- 3. Art. 70010AS00



LAVABO / WASHBASIN
Art. 70521AS00

BIDET / BIDET
Art. 71522AS00
Art. 70904AS00

ACCESSORI / ACCESSORIES
Art. 70001AS00
Art. 70033AS00
Art. 70022AS00
Art. 70027AS00
Art. 70010AS00

DOCCIA / SHOWER
Art. 70131AS0D



INNATEFLAIR



Art. 70521AS00



Art. 73540AS00



TIME 2020 WOOD

DOCCIA / SHOWER
Art. 70976AS00
Art. 69524AS0
Art. 00888AS74PR

LAVABO / WASHBASIN
Art. 69539AS00

VASCA / BATHTUBE
Art. 69534AS0D

BIDET / BIDET
Art. 69522AS00

ACCESSORI / ACCESSORIES
Art. 70010AS00
Art. 70033AS00
Art. 70904AS00



DOCCIA / SHOWER
 Art. 70976AS00
 Art. 69524AS0
 Art. 00888AS74PR

LAVABO / WASHBASIN
 Art. 69539AS00

VASCA / BATHTUBE
 Art. 69534AS0D

BIDET / BIDET
 Art. 69522AS00

WC / WC
 Art. 70944AS00
 Art. 70033AS00



ACQUAVIVA

DESIGN CENTER DIRECTED BY **ANTONIO BONGIO**
WITH THE COLLABORATION OF **MARCO POLETTI, GIANCARLO VEGNI**
CONCEPT **ROBERTO NICCOLAI**



#Tattoo

Art. 56539TT1830

#Freedom

Art. 56539CR18PA

RIVAHT

DESIGN BY **MARCO POLETTI**



Art. 58521CR00

ORIENTAL
ECHOS

#ARTOFWATER

Pureglam

DESIGN BY FEDERICO ROSSI



#glamourblack&white

Love for
Swarovski®

Art. 6L501NE02SW



DOCCIA / SHOWER
Art. 3P889NE00
Art. 00834NE00
Art. 3P524NE02
Art. 3P525NE02

LAVABO / WASHBASIN
Art. 0B400AV00
Art. 6P538NE22Z2

BIDET / BIDET
Art. 3P522NE02
Art. 00914NEID
Art. 43009NEDA
Art. 44033NE00

VASCA / BATHTUB
Art. 3P534NE020D

ACCESSORI / ACCESSORIES
Art. 43001NEDA
Art. 43022NEDA
Art. 43027NEDA

BONGIOCASA
Art. SI303BI20
Art. 0B401AW00
Art. DR102NEUB



Soffi

DESIGN BY MASSIMILIANO DELLA MONACA



#refinedshapes

PUREZZA ARTIGIANALE

Handcrafted purity

Espressione massima della maestria artigianale italiana tramandata da generazioni, SOFFI è un elegante connubio tra il nostro materiale primario, l'ottone, e l'autentico vetro soffiato di Murano. La versione in bianco e foglia oro rende la collezione la soluzione perfetta per ambienti prestigiosi tra suggestioni presenti e passate.

The highest expression of Italian craftsmanship handed down through generations, SOFFI is an elegant combination of our favourite material, brass, and authentic hand-blown glass of Murano. The version in white and gold leaf makes this collection the perfect choice to decorate prestigious living spaces, playing on concepts that are evocative of both past and present.

#elegantsuggestions



- 1. Art. 60978CRZZ / 60524CR00
- 2. Art. 60978CR77 / 60574CR00
- 3. Art. 60978CR88 / 60981CR88 + 60804CR40
- 3. Art. SL305BI20



DOCCIA / SHOWER
 Art. 60961OR88 + 60804OR30
 Art. 60960CR88 + 60804OR40
 Art. 60961CR88 + 60804CR30
 Art. 60830OR00
 Art. 60514OR44

LAVABO / WASHBASIN
 Art. 60514OR44
 Art. 60978OR44

VASCA / BATH
 Art. 60520CR00
 Art. 60520OR00



MIYAMIX

DESIGN BY MARCO POLETTI

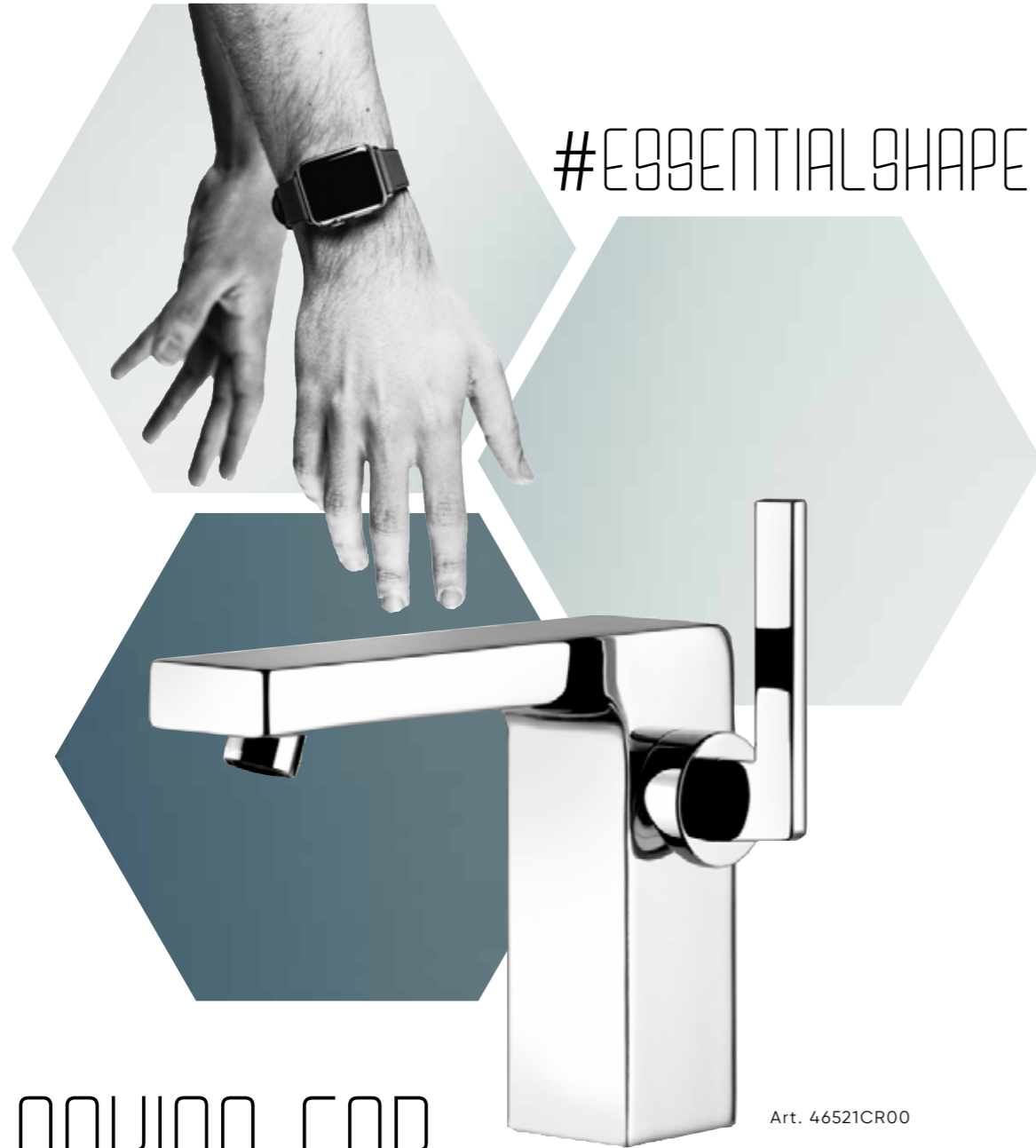

#ESSENTIALSHAPE

LOOKING FOR
PERFECTION

Art. 46521CR00

MIYAMIX CRYSTAL

DESIGN BY
MARCO POLETTI WITH MASSIMILIANO DELLA MONACA



NOTHING
BUT
SEDUCTION

#love^{at}
firstSight

Art. 48521CRAG

Mini One

DESIGN CENTER DIRECTED BY
ANTONIO BONGIO
DESIGN BY
MARCO POLETTI

life
in
colors



Intelligent design

Art. 41532CR15

M O O N

DESIGN BY **MARCO POLETTI**



#makeawish

cosmic
harmony

Art. 39521CR00



ADI DESIGN INDEX
2002 Award

BOWLING

DESIGN BY FEDERICO ROSSI

#SOPHISTICATEDMOOD

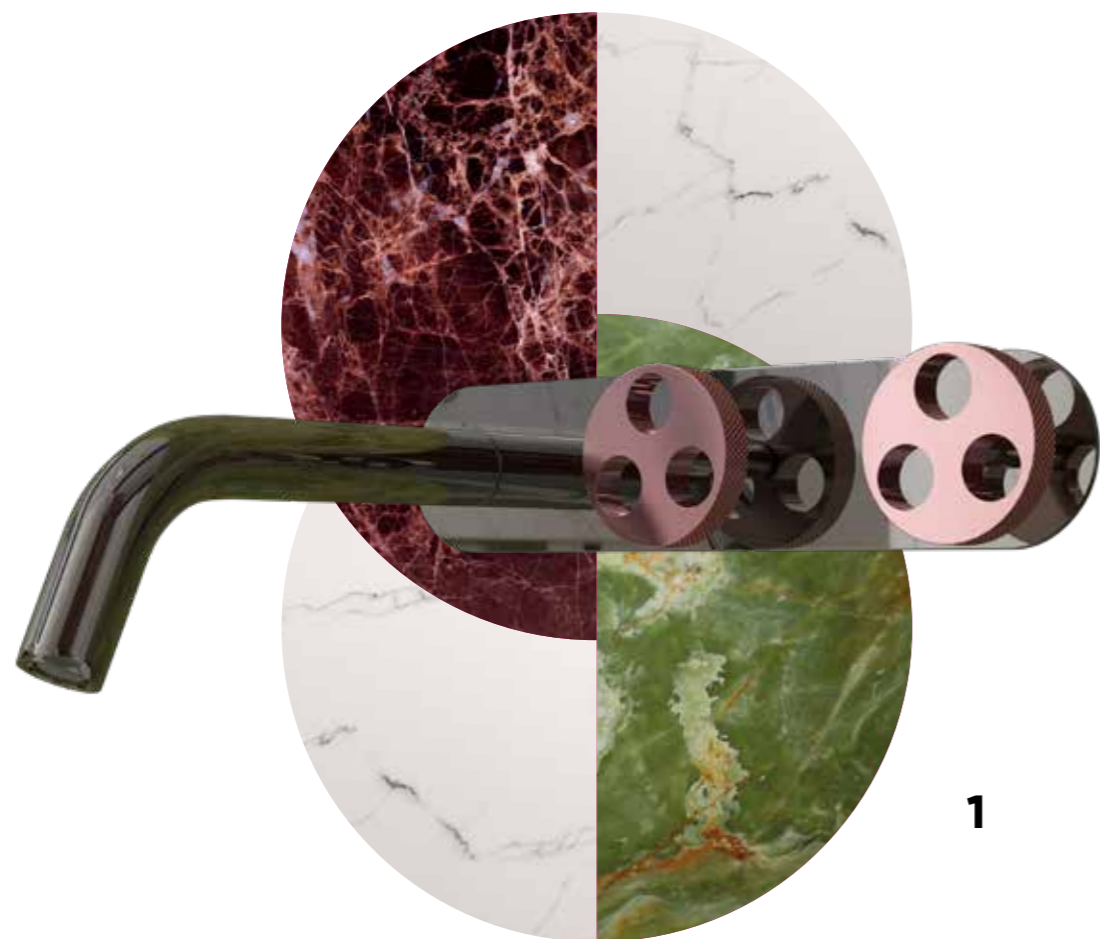

1

DESIGN iNNOVATION



DESIGN BY MARCO POLETTI



SOFISTICATO E INFORMALE

Sophisticated and informal

I contrasti cromatici delle superfici esaltano il carattere vivace e ricercato di BOWLING. Le linee essenziali e le eleganti finiture in cromo nero e oro rosa si inseriscono perfettamente in progetti d'arredo dal fascino sofisticato e dall'appeal contemporaneo.

The contrasting colours of the surfaces enhance BOWLING's vibrant and exclusive character. The essential lines and elegant finishes in black chrome and rose gold fit perfectly in interior design projects with a sophisticated charm and contemporary appeal.



2



#FIRSTCLASSELEGANCE

1. Art. 38541CNOA
2. Art. SW880NENE



DOCCIA / SHOWER
 Art. 38500CNOA
 Art. 00830CNOE
 Art. SW880NENE

LAVABO / WASHBASIN
 Art. 38501FARS



LAVABO / WASHBASIN
 Art. 38500CNOA
 Art. 38541CNOA

VASCA / BATHTUB
 Art. 38541CNOA

ARREDI / FURNITURE
 Art. 38030/R + 877CN00

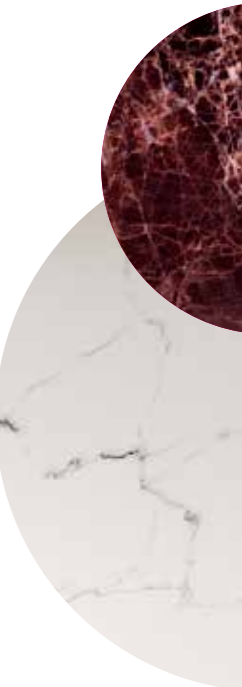

A C Q U A
C A R I C A

DESIGN BY FEDERICO ROSSI

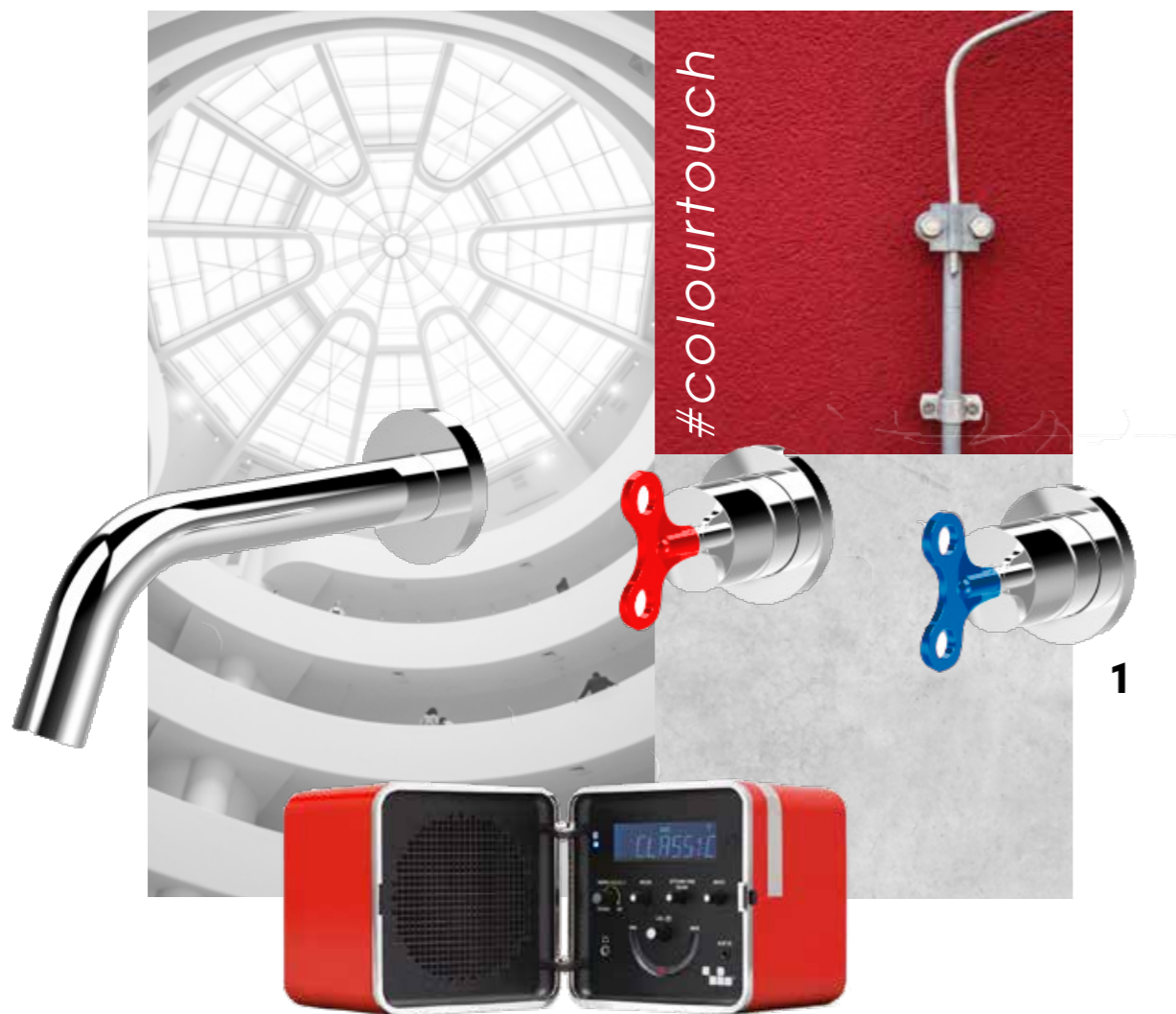

ESSENTIAL _
WHITE



#modernist 2



#singleattitude

LA CHIAVE DELLA VERSATILITÀ

The key to versatility

Una collezione easy di monocomandi dall'apertura a chiave pratica e funzionale. La disponibilità in vari colori libera la creatività nell'arredo di bagni e cucine rendendo ACQUACARICA protagonista di ambienti residenziali e commerciali dall'appeal contemporaneo.

An easy-going collection of single levers with a practical and handy key-opening. The several colours available for this collection allow you to let your imagination run wild when choosing the furnishing items to decorate your kitchen and bathroom, and make ACQUACARICA the undisputed star of residential and commercial spaces with a contemporary appeal.

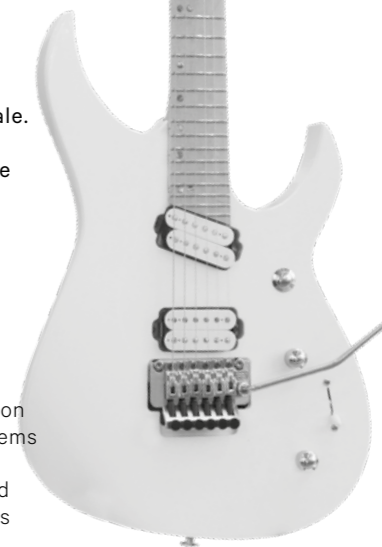

1. Art. 63540CRHC
2. SI300MOND

LAVABO / WASHBASIN
Art. 6354ONSHC

VASCA / BATHTUB
Art. 63530NSHCD

ACCESSORI / ACCESSORIES
Art. 30027NS00
Art. 00067RS0Q

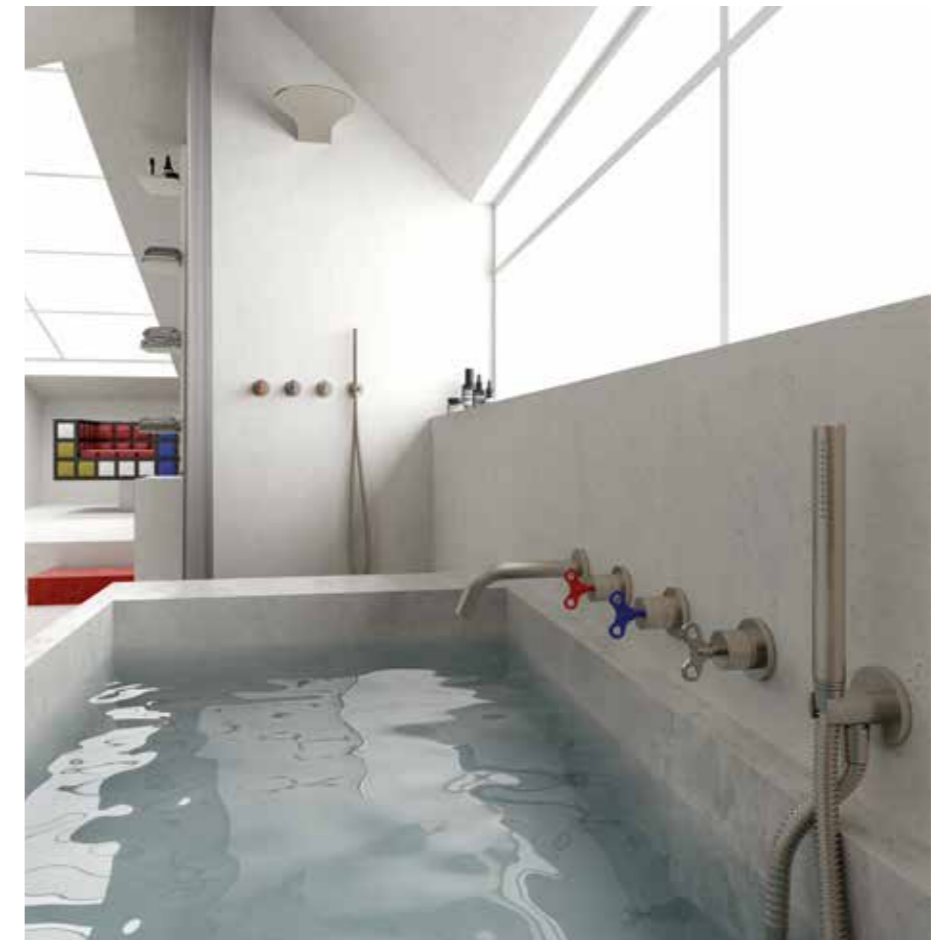

AQUA

DESIGN CENTER DIRECTED BY
ANTONIO BONGIO



1

Perfect imperfections

- 1. Art. 40538OR220R
- 2. Art. 30027OR00
- 3. BONGIOCASA Pouf "Sweet In.Grid"
Art. SI301BI20



MINIMAL CHIC

L'ambiente luminoso e total white si riflette in un gioco di specchi dove le linee essenziali, ispirate a geometrie curve, e la finitura in oro spazzolato della rubinetteria diventano protagoniste dello spazio. Disponibile in numerose versioni, AQUA propone un fascino minimal chic di estrema raffinatezza e stile.

The total white and bright environment is reflected in a juxtaposition of mirrors where the essential lines, curved geometries and finishes in brushed gold of the kitchen and bathroom taps become the focus of the living space they decorate. Available in several versions, AQUA offers a minimal chic appeal that is highly sophisticated and stylish.



2



3



#LUXURY



LAVABO / WASHBASIN
Art. 40538OP220R

LAVABO 2 / WASHBASIN 2
Art. 40501OPPO
Disponibile su richiesta /
Available upon request

BIDET / BIDET
Art. 40503OPOR

DOCCIA / SHOWER
Art. 40554OPOR
Art. 40498OPOR
Art. 867OPNR
Art. 00790OPPR
Art. 00830OP00

ACCESSORI / ACCESSORIES
Art. 30001OP00
Art. 30007OP40
Art. 30009OP02
Art. 30022OP00
Art. 30027OP00
Art. 30025OP00



DOCCIA / SHOWER
 Art. 40554OPOR
 Art. 40498OPOR
 Art. 00867OPNR
 Art. 00790OPPR
 Art. 00830OP00

BONGIOCASA - POUF "SWEET IN.GRID"
 Art. SI301BI20



LAVABO / WASHBASIN
 Art. 40501CNKA



LAVABO / WASHBASIN
 Art. 40321ORPO

DOMINO·Q

DESIGN CENTER DIRECTED BY
ANTONIO BONGIO

#SOPHISTICATED



ATTENTION TO DETAILS

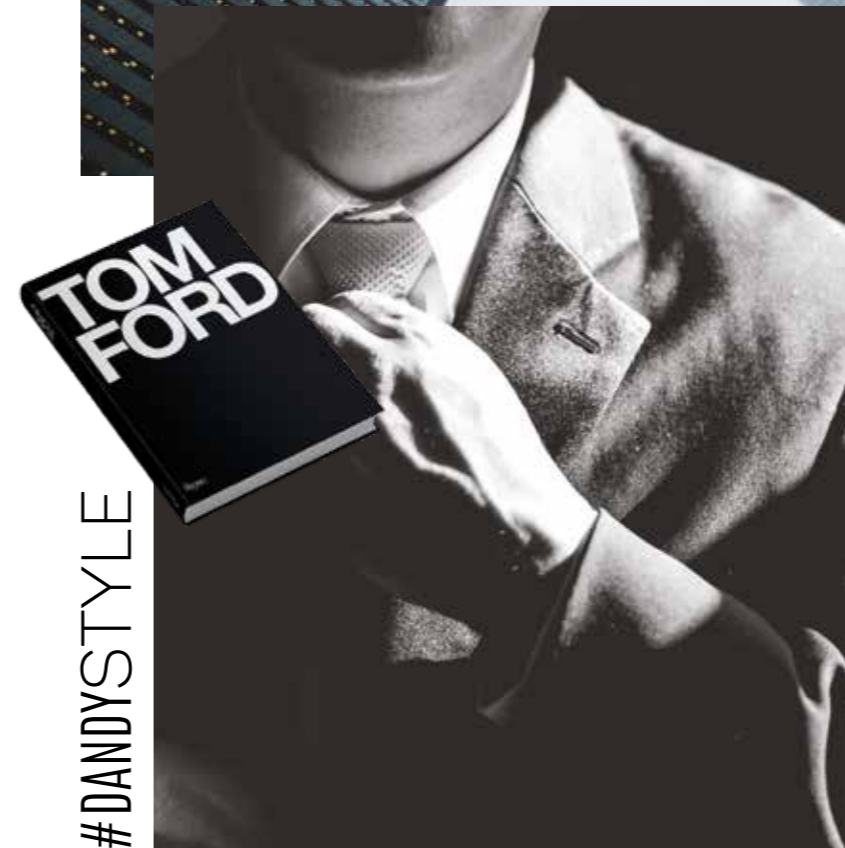

#DANDYSTYLE

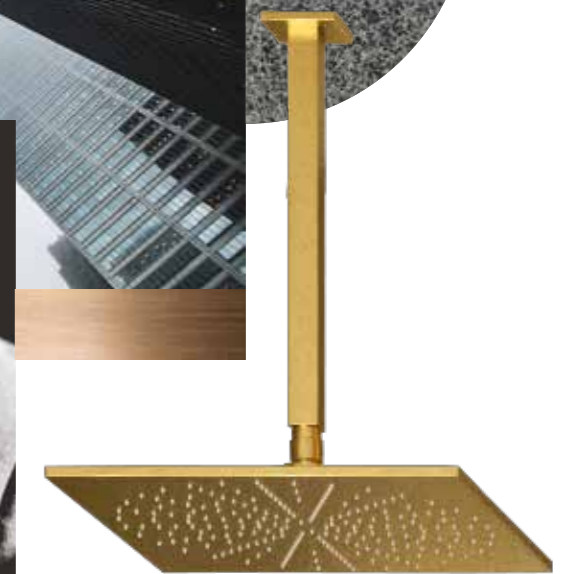

DETTAGLIO DI CARATTERE

Detail with a strong character

L'eleganza delle linee geometriche e le loro proporzioni armoniche fanno di DOMINO Q una collezione dal carattere forte e deciso. La finitura bronzo si coniuga perfettamente con l'essenza naturale della materia. L'attenzione ai dettagli che contraddistingue la serie rende sofisticato ogni ambiente.

The elegance of its geometric lines and harmonious proportions make DOMINO Q a collection with a strong and resolute personality. The bronze finish perfectly blends with the natural essence of the raw material. The attention to detail that distinguishes this series makes every environment more sophisticated.





LAVABO / WASHBASIN
Art. 43501BRDA

BIDET / BIDET
Art. 43522BRDA

DOCCIA / SHOWER
Art. 67524BRPR
Art. 00834BR0EPR
Art. 0087BR00+00801BR30

ACCESSORI / ACCESSORIES
Art. 43007BR60
Art. 43027BRDA
Art. 43009BRDA
Art. 44033BR00

BONGIOCASA
Art. DR100NEUB



LAVABO / WASHBASIN
Art. 43501ORDA

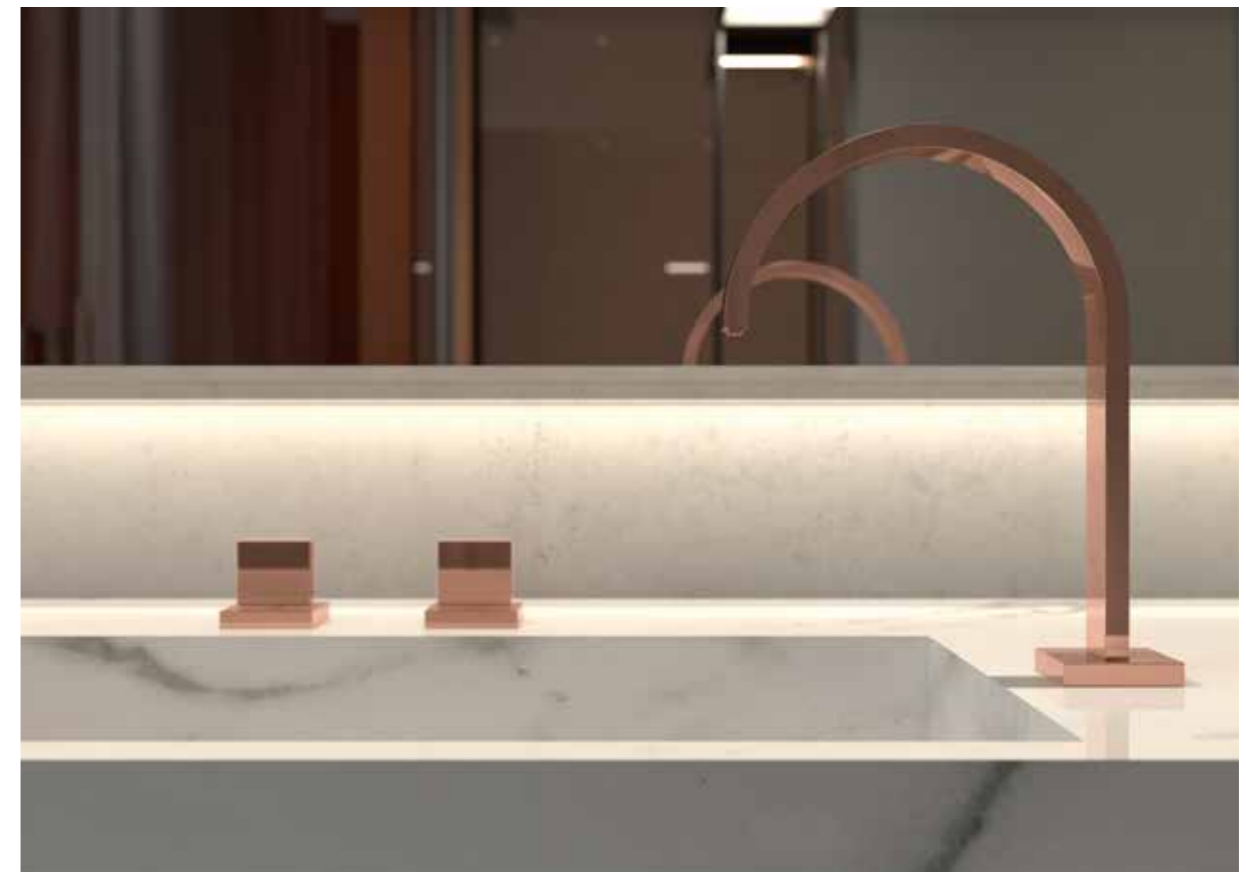

LAVABO / WASHBASIN
Art. 43501OPDA

STELTH

DESIGN BY MARCO POLETTI



STELTH

#naturalbashion



ELEGANTI CONTAMINAZIONI

Elegant cross-overs

Una collezione di rubinetteria e accessori caratterizzata da superfici planari che riflettono la luce. Un taglio a diamante per una serie raffinata, collocata in importanti progetti di prestigio internazionale come l'hotel Ritz Carlton, Jumeirah Beach Dubai e il lussuoso Negarestan Complex a Teheran.

A collection of kitchen and bathroom taps and accessories whose distinct feature are the flat, level surfaces that reflect light.

A diamond-cut design for a refined series used for the interior design of the world's leading hotels like the Ritz Carlton, Jumeirah Beach Dubai and the luxurious Negarestan Complex in Teheran.



#travelgram



1. Art. 01521CN00
2. Art. 01524CN00 + Art. 01881NE00
3. Art. 01001CN00



LAVABO / WASHBASIN
Art. 01521CN00

DOCCIA / SHOWER
Art. 01519CN03
Art. 00834CN0EPR
Art. 00867CNNO
Art. 01881CN00

VASCA / BATHTUB
Art. 01534CR0D

ACCESSORI / ACCESSORIES
Art. 01007CN60
Art. 43027CNDA
Art. 01001CN00
Art. 01007OR40



#naturalcomfort



#Higherbetter



O'CLOCK GREEN

DESIGN BY MARCO POLETTI



#SEACOLORS

COZY ATMOSPHERE

1

TECNOLOGICA ELEGANZA

Technological elegance

Il design originale e il sistema Energy Economy System fanno di O'CLOCK un prodotto che associa l'eleganza alla tecnologia, rendendolo ideale per spazi contemporanei e ricercate ristrutturazioni in cui tradizione e innovazione coesistono perfettamente.

The original design and the Energy Economy System make O'CLOCK GREEN a product that couples elegance with technology, making it the ideal choice to decorate contemporary spaces and elaborate renovation works, where tradition and innovation perfectly coexist.



2

#CAPRISTYLE



3

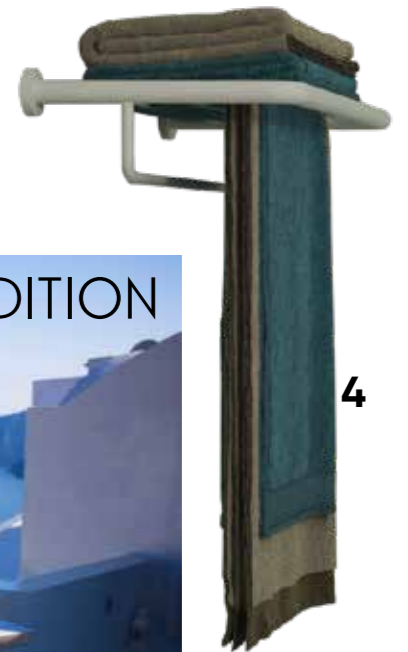

4

- 1. Art. 14538CR22GR
- 2. Art. 14889CR00
- 3. Art. 14522CRGR
- 4. Art. 04101BI00

#NEWTRADITION





LAVABO / WASHBASIN
Art. 14538BI22GR

BIDET / BIDET
Art. 14522BIGR

DOCCIA / SHOWER
Art. 14889BI00
Art. 14529BI00
Art. 830BIPRM1

VASCA / BATHTUB
Art. 14534BI0D

ACCESSORI / ACCESSORIES
Art. 44001BI00
Art. 30027BI00
Art. 44033BI00
Art. 04101BI00



#RETROCONTEMPORARY



O'CLOCK

DESIGN BY MARCO POLETTI

#ONEMORETIME



Art.14521CRPR

IT'S TIME TO *CHANGE*



#DYNAMIC



LA BELLEZZA DELLA SEMPLICITÀ

The beauty of simplicity

Con le sue forme sinuose, semplici e sempre attuali O'CLOCK ricorda che la funzione non è secondaria al design. Perfetto in spazi contemporanei o in progetti di ristrutturazioni, incarna un'idea di modernità che sa convivere con ogni stile.

With its sinuous, simple and timeless shapes, O'CLOCK reminds us that function is no less important than design. Perfect for contemporary spaces or renovation projects, this line embodies an idea of modernity that knows how to blend in with any style.

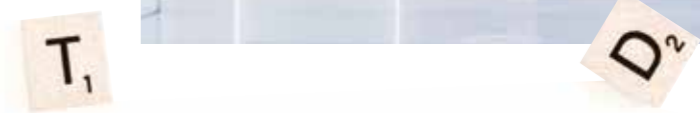

#ESSENTIALLINE

T CROSS

T LEVER

DESIGN CENTER DIRECTED BY
ANTONIO BONGIO

#materialmix



1

NATURAL
comfort

#stylishmood



DESIGN FUNZIONALE

Functional design

L'originale design con manopole a croce e il sistema a risparmio d'acqua fanno di T CROSS un prodotto che coniuga innovazione ed estetica. Gli accessori sono dettagli che ispirano uno stylish mood contemporaneo declinabile secondo diverse interpretazioni abitative.

The original design with cross knobs and the water-saving system make T CROSS a product that skilfully combines innovation and aesthetic appeal. The accessories are details that inspire a stylish contemporary mood which can be customised to fit your particular furnishing style.



3

- 1. Art. 30499CR00
- 2. Art. 30537CR0D
- 3. Art. 30530CRSS



LAVABO 1 / WASHBASIN 1
Art. 30321CR00

LAVABO 2 / WASHBASIN 2
Art. 30401NS00

DOCCIA / SHOWER
Art. 30537CR0D

VASCA / BATHTUB
Art. 30430CR0D

ALCOR

DESIGN CENTER DIRECTED BY
ANTONIO BONGIO

#INDUSTRIALCHIC

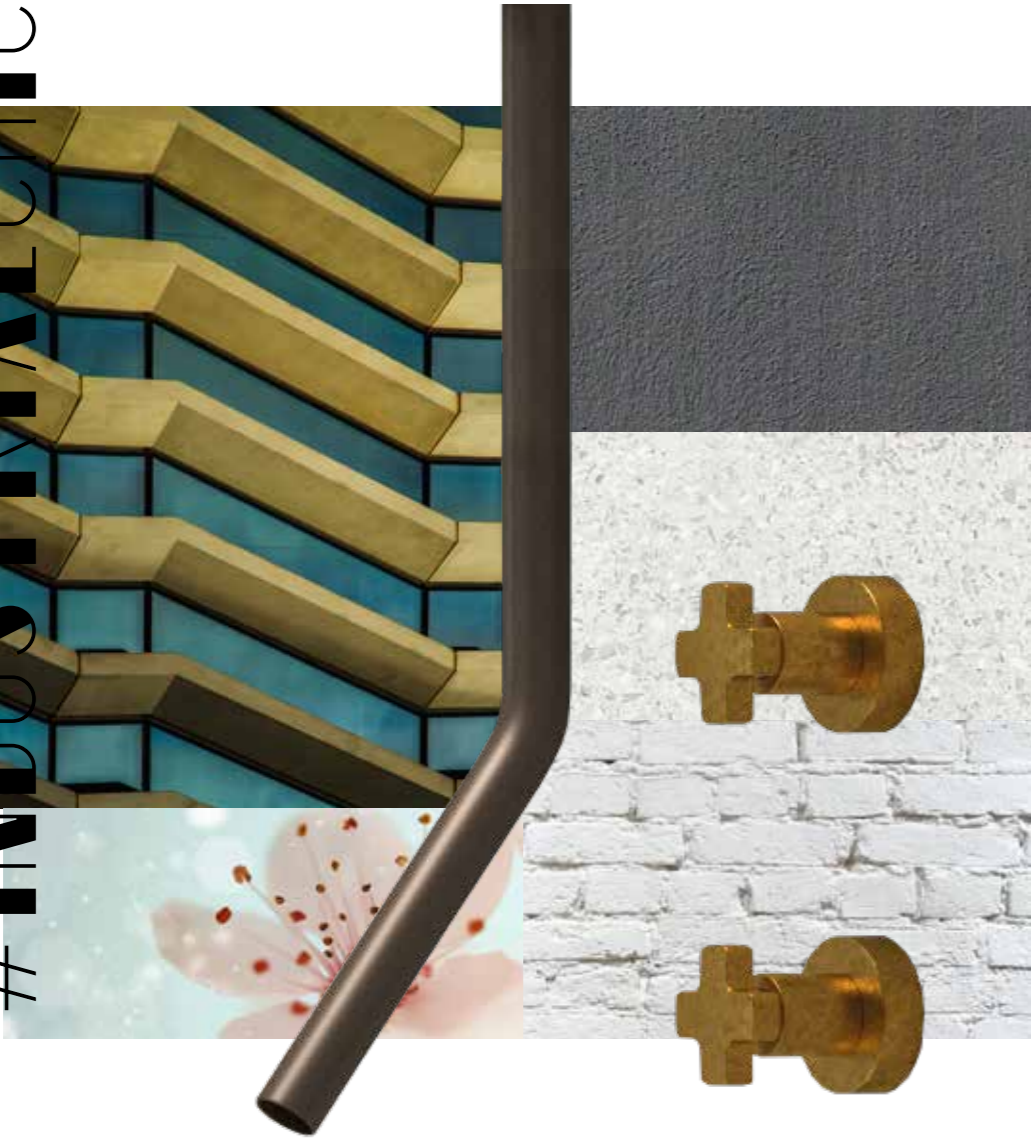

THE CULTURE OF MATERIALS

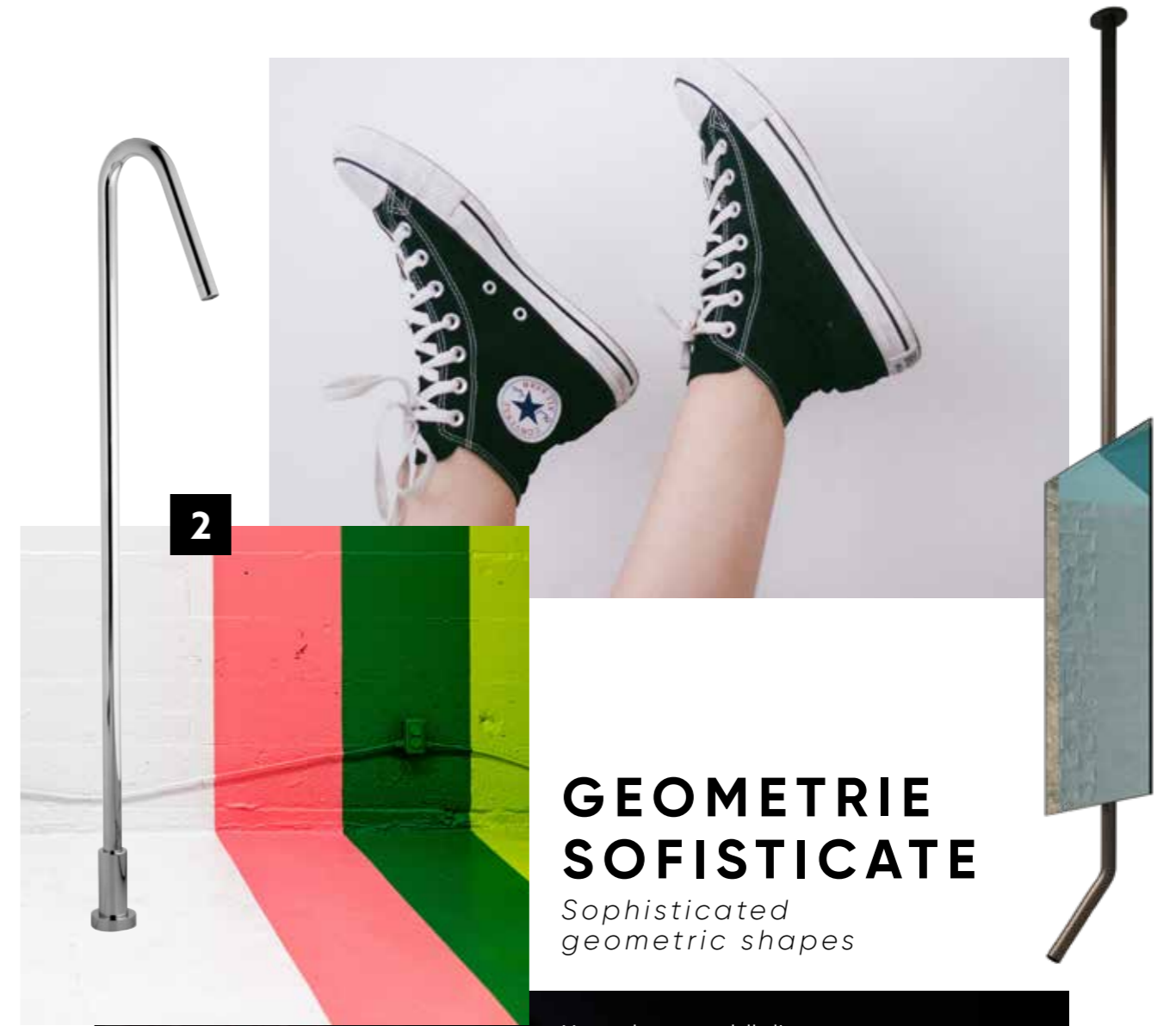

**GEOMETRIE
SOFISTICATE**
*Sophisticated
geometric shapes*

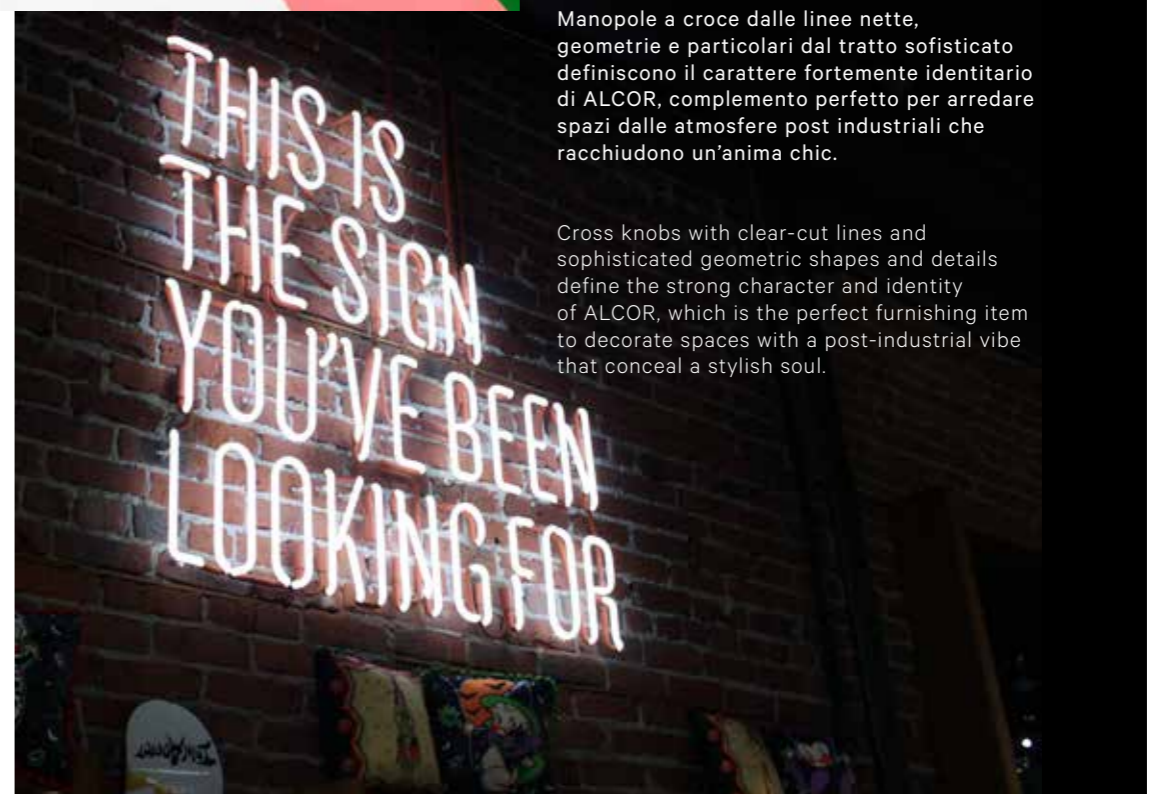

Manopole a croce dalle linee nette, geometrie e particolari dal tratto sofisticato definiscono il carattere fortemente identitario di ALCOR, complemento perfetto per arredare spazi dalle atmosfere post industriali che racchiudono un'anima chic.

Cross knobs with clear-cut lines and sophisticated geometric shapes and details define the strong character and identity of ALCOR, which is the perfect furnishing item to decorate spaces with a post-industrial vibe that conceal a stylish soul.



SPECIAL THANKS TO

 atlas concorde

www.atlasconcorde.com

ALCOR

LAVABO / WASHBASIN
 Art. 42400BU00
 Art. 00877RB00 +
 Art. 38030/Q pag. 1007

DOCCIA / SHOWER
 Art. 42400BU00
 Art. 42425BU00
 Art. 00830RB00
 Art. 00804RB00
 Art. 00882RB00

VASCA / BATHTUB
 Art. 42400BU00
 Art. 00985RB70

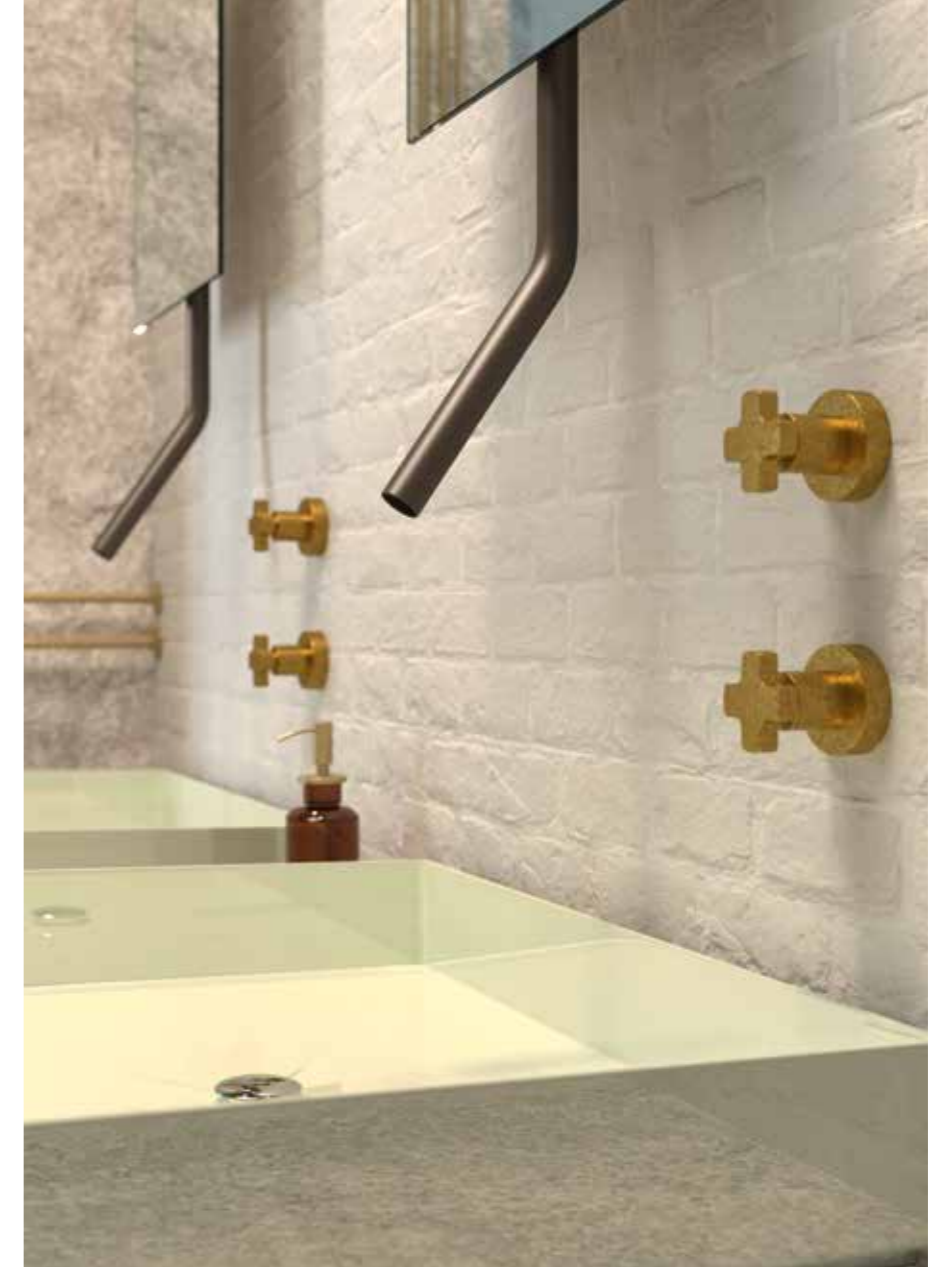

ROYALE 80 & IMPERO

DESIGN CENTER DIRECTED BY
ANTONIO BONGIO



INNATE PASSION FOR LUXURY



SCENOGRAFIE FUNZIONALI

Functional scenic designs

Prezioso nelle finiture e tecnologico nelle funzionalità, ROYALE80 è una collezione di impatto scenografico che arricchisce tutti gli ambienti dal mood decorativo accentuato come quelli dell'hôtellerie e degli spazi dell'ospitalità. I cristalli Swarovski® e la raffinata lavorazione dei metalli lo rendono adatto anche ad applicazioni residenziali dal gusto ricercato.

Owing to its elegant finishes and sophisticated technological features, ROYALE80 is a collection with a strong visual impact that is meant to decorate environments with an accentuated decorative mood like those we find in hotels and accommodation facilities. The Swarovski® crystals and elegant metal finishes, though, also make it suitable for residential applications with a refined taste.

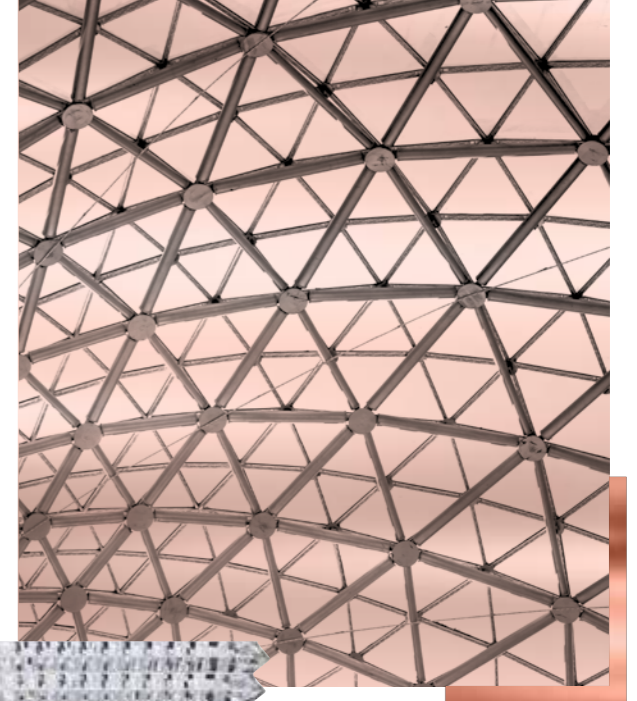

2



- 1. Art. 24501OAST
- 2. Art. 06004OA00
- 3. Art. 24530OA0DST

LAVABO / WASHBASIN
Art. 24501OAST

BIDET / BIDET
Art. 24503OAST

DOCCIA / SHOWER
Art. 00888OAC4RPR
Art. 06524OA00
Art. 06556OA00
Art. 00867OANR
Art. 00893OA0R

VASCA / BATHTUB
Art. 24530OA0DST

ACCESSORI / ACCESSORIES
Art. 06001OA00
Art. 06004OA00
Art. 06008OA00
Art. 06014OA00
Art. 06015OA00
Art. 21025OA00
Art. 04104OA00
Art. 04101OA00
Art. 44033OA00

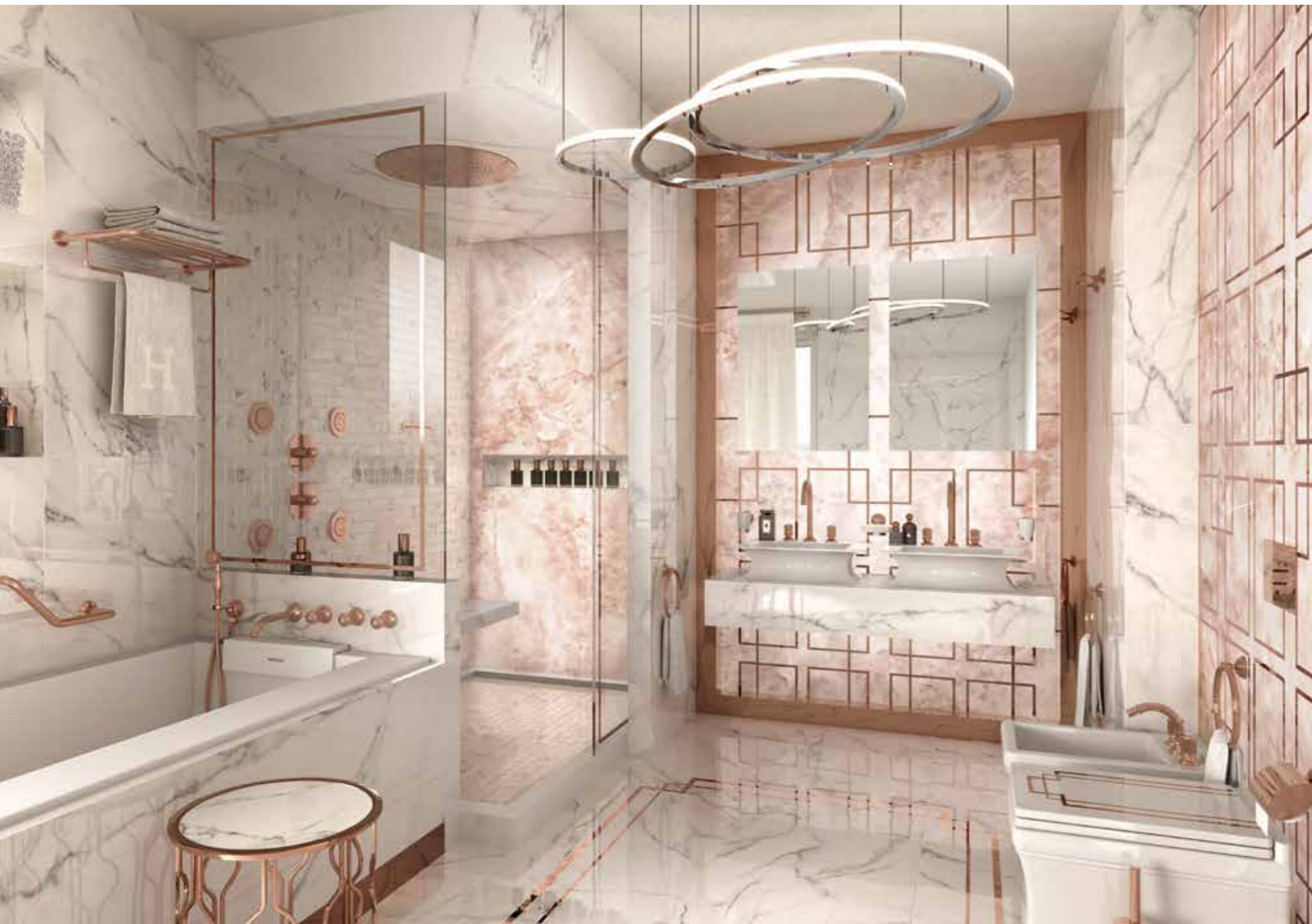

#PRICELESSBEAUTY

FLEUR

DESIGN CENTER DIRECTED BY
ANTONIO BONGIO

#PRECIUOSDETAILS



Art. 12501OR00

ECLECTIC MOOD

LUSO ESCLUSIVO

Exclusive luxury

Le linee floreali dorate a 24 carati e gli inserti in porcellana bianca e nera rendono FLEUR la soluzione perfetta non solo per le più esclusive applicazioni del lusso internazionale, ma anche per ambienti bagno di diversa ispirazione, cui si voglia conferire una connotazione di inconfondibile prestigio.

The 24-carat gold floral lines and black-and-white porcelain inserts make FLEUR the perfect solution not only for the most exclusive international luxury applications, but also for bathrooms with a different source of inspiration, where the aim is to give the living space a touch of unmistakable prestige.

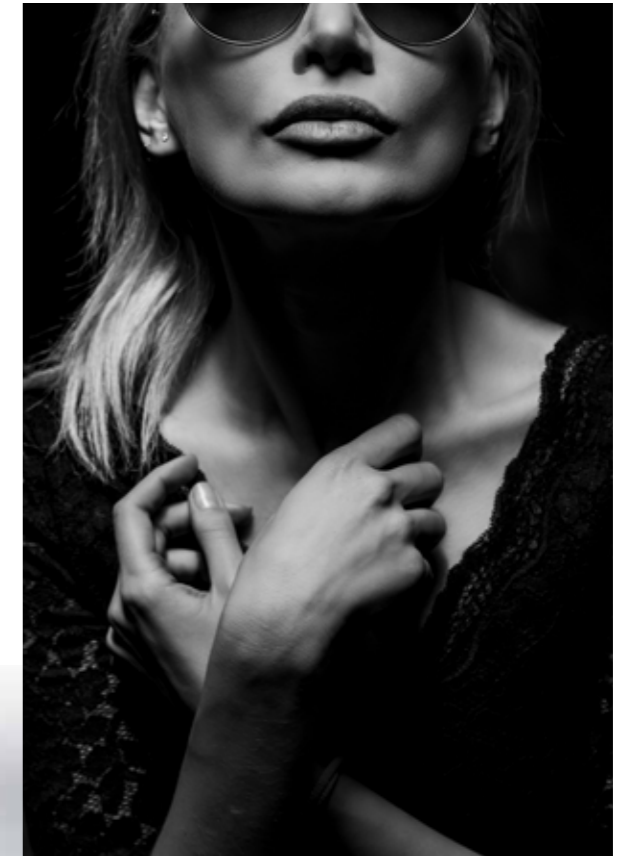

#GOLD&BLACKALLURE



DOCCIA / SHOWER
 Art. 00888OR55
 Art. 12542OR04
 Art. 00831OR00
 Art. 00867ORNR

LAVABO / WASHBASIN
 Art. 12501OR00

ACCESSORI / ACCESSORIES
 Art. 11012OR00
 Art. 11018OR00
 Art. 11007OR50
 Art. 11001OR00
 Art. 04042OR00

VASCA / BATHTUB
 Art. 12535OR0D



#GOLDENAGE



RIVOLI

DESIGN CENTER DIRECTED BY
ANTONIO BONGIO

#charminglover



Art. 05521CR00

TIMELESS BEAUTY

RADIANT

DESIGN CENTER DIRECTED BY
ANTONIO BONGIO

#GOLDENAGE

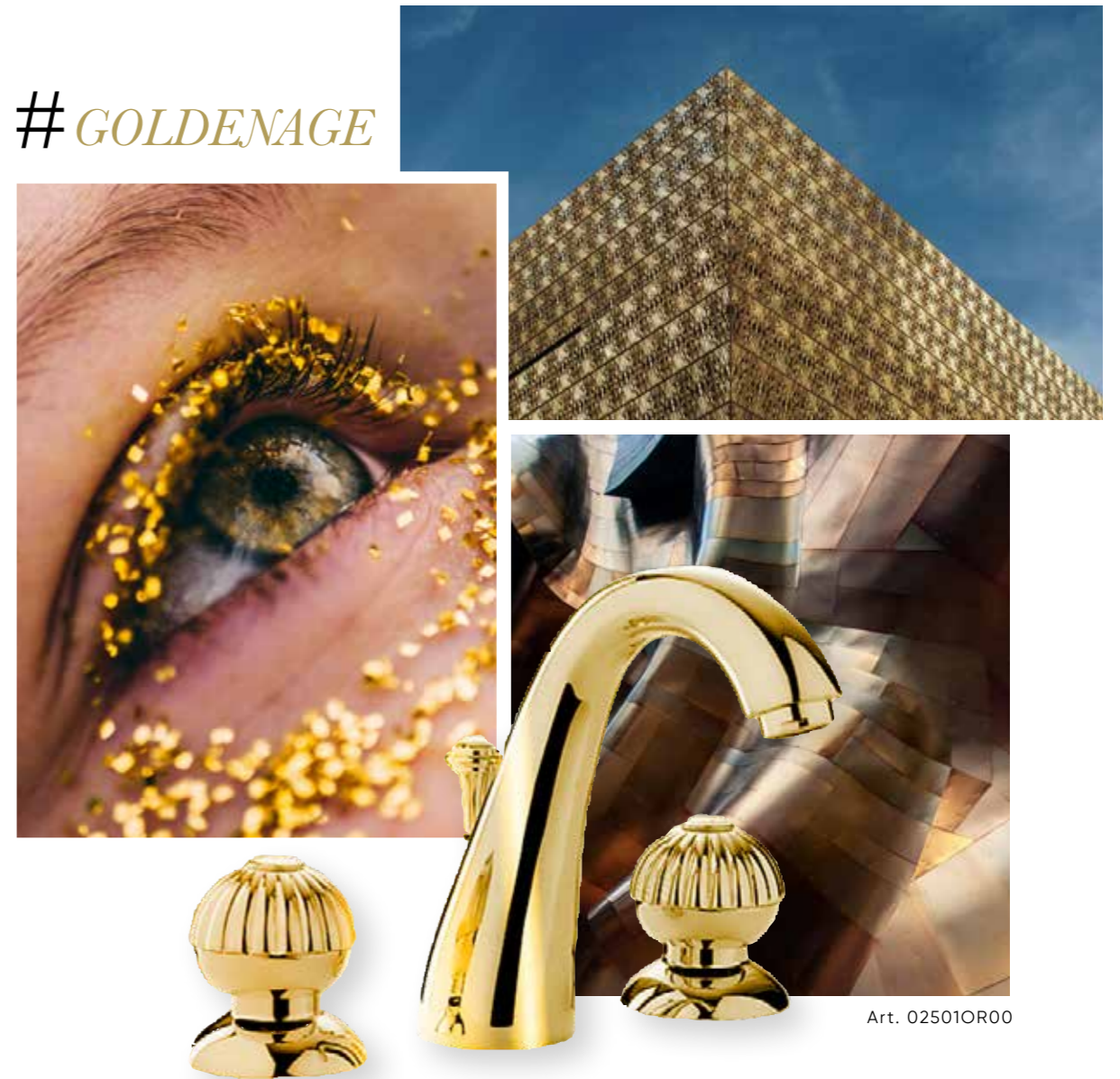

Art. 02501OR00

LUXURY ATTRACTION

AXEL

DESIGN CENTER DIRECTED BY ANTONIO BONGIO

#BEDIFFERENT



I AM NOT THAT COMMON

1



#SIMPLICITY

2

- 1. Art. 15501FA00
- 2. Art. 15528FA00
- 3. Art. 15014CRO0



3



#WEAVING



IL FASCINO DELLA MATERIA

The charm of the raw material

AXEL reinterpreta la rudezza della materia a effetto retrò con il design e la tecnologia più evolute, per arredare gli spazi della contemporaneità metropolitana. La sua finitura in ferro antico e gli accessori in stile classico sono ideali per il recupero architettonico di ambienti dalla forte personalità.

AXEL reinterprets the rawness of matter with a retro style featuring the most advanced design and technology to furnish modern-day cities. Its antique iron finish and classic accessories are ideal for the architectural restoration of environments with a strong personality.



#POLISHEDFINISH

LAVABO / WASHBASIN
Art. 15501FA00

BIDET / BIDET
Art. 15522FA00

DOCCIA / SHOWER
Art. 15537FA0D

VASCA / BATHTUB
Art. 15528FA00
Art. 15528CR00

ACCESSORI / ACCESSORIES
Art. 15001FA00
Art. 15007FA60
Art. 15008FA00
Art. 15014FA00
Art. 15015FA00
Art. 30025FA00



#METROPOLITAN



Cristallo

DESIGN CENTER DIRECTED BY
ANTONIO BONGIO

#luxurybathroom



Art. 04501CR00

Style & Beauty

Oxford Lux · MilleNuits Capri · Madame · Zenith

DESIGN CENTER DIRECTED BY
ANTONIO BONGIO

#decorativemood



Art. 22501OR00

Exclusive CLASS

LA TOSCA

DESIGN CENTER DIRECTED BY
ANTONIO BONGIO

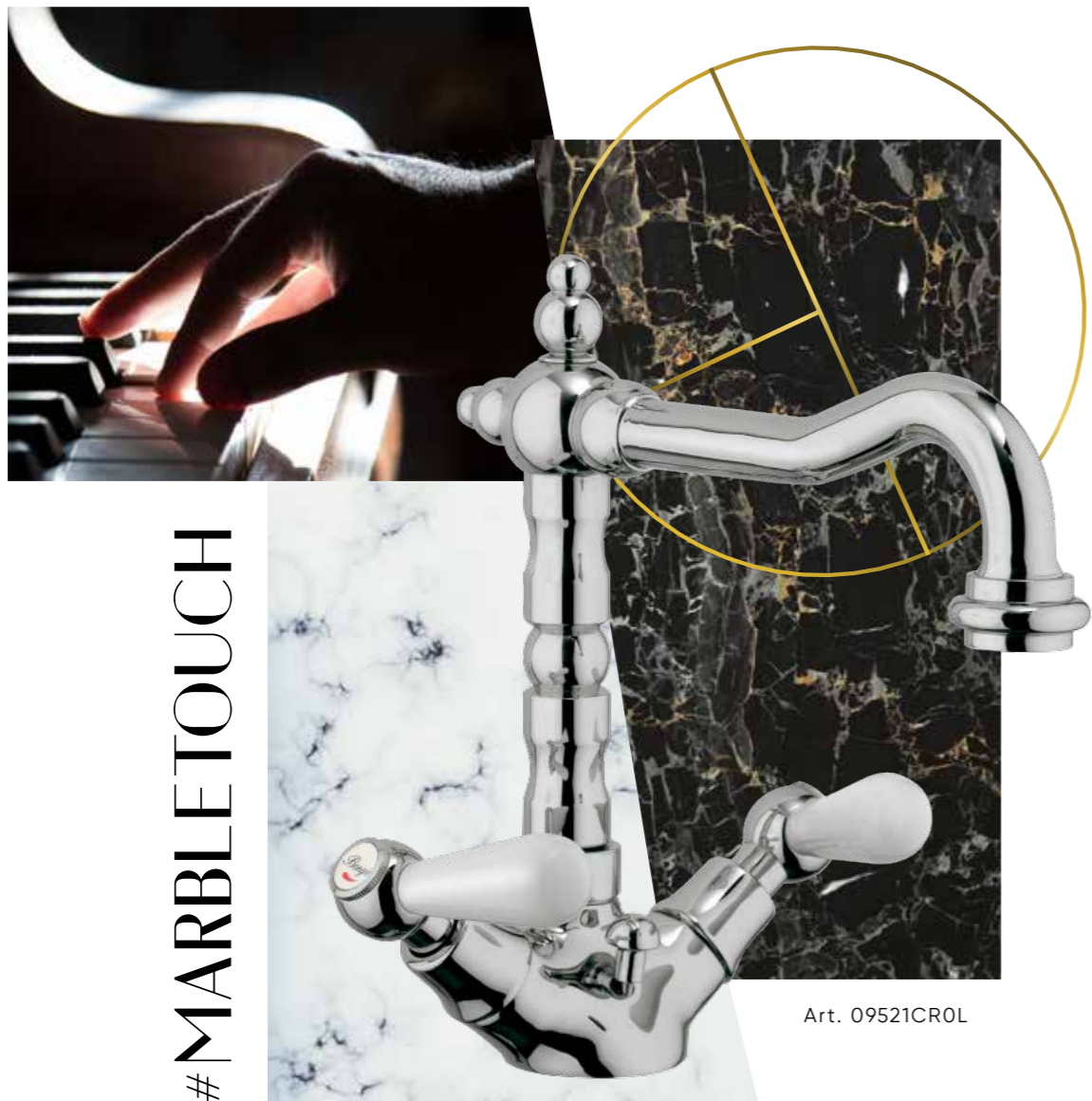

#MARBLETOUCH

Art. 09521CR0L

ORNAMENTAL
style

TURANDOT

DESIGN CENTER DIRECTED BY
ANTONIO BONGIO



Art. 10521CR0L

A TOUCH OF
CLASSIC ELEGANCE

T MIX18

DESIGN CENTER DIRECTED BY
ANTONIO BONGIO

#DECOR
EVERYWHERE



UNLEASH
YOUR CREATIVITY



RIGORE E SEMPLICITÀ

Rigour and simplicity

La particolare apertura della bocca, le forme rigorose e le linee rigide e minimali rendono T MIX18 il complemento d'arredo ideale per ambienti che fanno della linearità e della pulizia formale il proprio mood.

The special opening of the spout, the jagged, sharp lines and the minimal shapes make T MIX18 the ideal furnishing item for environments where linearity and formal clarity set the mood.

#MIXANDMATCH



1. Art. 08538CRPR
2. Art. 47132CR00
3. Art. 43007CR60DA

#GRAPHICLOOK



SPECIAL THANKS TO

Tecnografica
italian wallpaper

www.tecnografica.net

T MIX18

LAVABO / WASHBASIN
Art. 08538CRPR

DOCCIA / SHOWER
Art. 47132CR00

VASCA / BATHTUB
Art. 08530CRODPR

ACCESSORI / ACCESSORIES
Art. 43001CRDA
Art. 43007CR60DA
Art. 43027CRDA



T·UBE

DESIGN BY FEDERICO ROSSI

#UNCONVENTIONAL

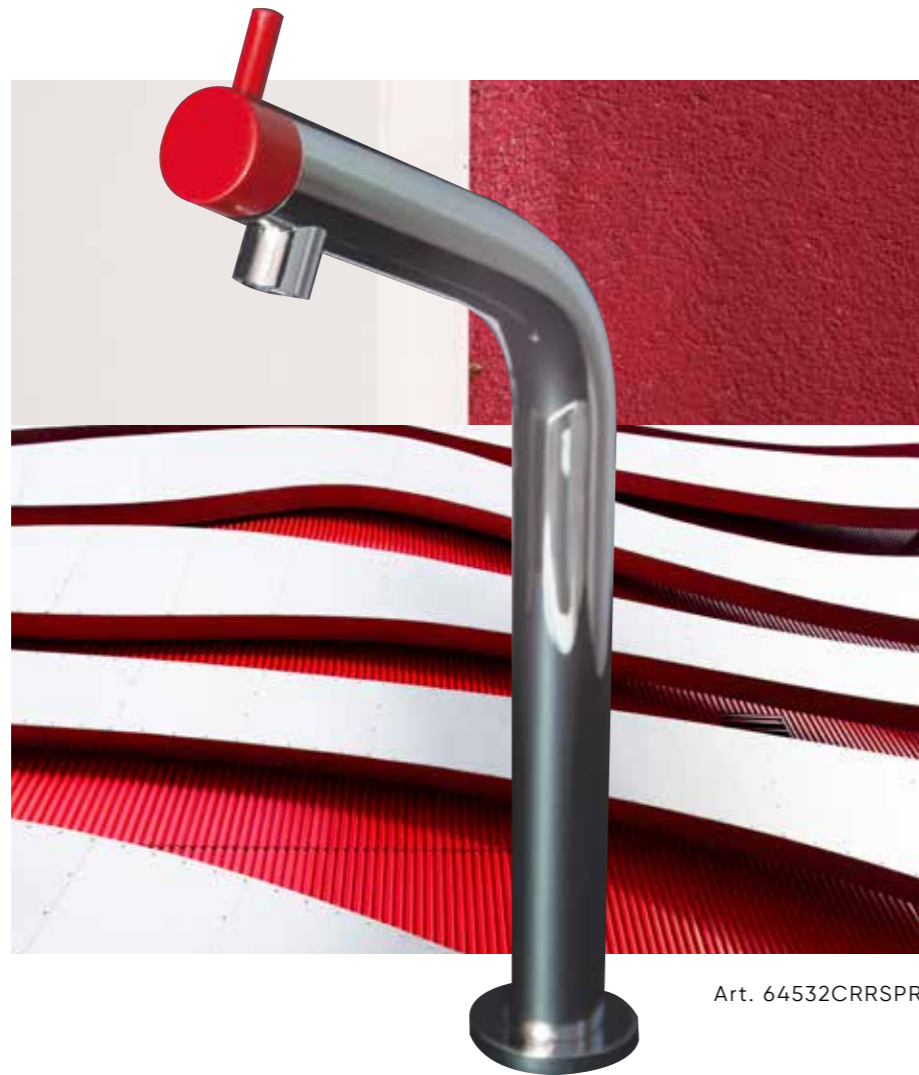

Art. 64532CRRSPR

MAKE THE DIFFERENCE



IRONIA CONTEMPORANEA

Contemporary irony

Essenziale e minimalista T.UBE abita il contemporaneo con personalità creativa. Le linee e le rifiniture colorate ne fanno un complemento d'arredo giocoso, adatto a inserirsi in ambienti pop che rileggono il mondo con ironia.

Essential and minimalist, T.UBE inhabits the contemporary with creative personality. Its coloured lines and finishes make it a playful furnishing item suitable to decorate pop-art environments that reinterpret the world with a sense of irony.



#SIMPLY CREATIVE



LAVABO / WASHBASIN
Art. 68439RSPR

DOCCIA / SHOWER
Art. 68524BIPR
Art. 008753136PR
Art. 00788CRC4QPR

COLONNA DOCCIA
/ SHOWER COLUMN
Art. 32131BIRS

ARREDI / FURNITURE
Art. 00067ES00
Art. 30007RS40
Art. DR201NE00
Art. DR200NE00
Art. S1306BI20



ON

DESIGN CENTER DIRECTED BY
ANTONIO BONGIO



#GEOMETRIES

DESIGN

ADDICTED



#GRAPHIC



2



SEMPLICE CON STILE

Simple, with style

ON si fa interprete di un'eleganza minimale e fuori dal tempo in cui forma e funzione si integrano perfettamente. Le linee rotonde e morbide si intersecano dando origine a un gioco di volumi, per un total look che conferisce carattere a ogni ambiente.

ON becomes the symbol of a minimal and timeless elegance where shape and function blend seamlessly. The round and soft lines intersect producing an interplay of volumes, for a total look that will add character to any living space.

- 1. Art. 68521RBPR
- 2. Art. 68534TTODPR
- 3. Art. DR200AN00

VASCA / BATHTUB
Art. 68534TTODPR

LAVABO / WASHBASIN
Art. 68532TTPR

BIDET / BIDET
Art. 68522TTPR

DOCCIA / SHOWER
Art. 00882TT00
Art. 00804TT30
Art. 68524TTPR
Art. 00866TT0R
Art. 00830TT00

ACCESSORI / ACCESSORIES
Art. 44033TT00
Art. 00067TT00
Art. DR200AN00
Art. DR102TTUB



bongio

ON

LAVABO / WASHBASIN
Art. 68501CNPR

LAVABO DA TERRA / FREE STANDING WASHBASIN
Art. 68533BIPR



LINE

DESIGN CENTER DIRECTED BY
ANTONIO BONGIO

#citylife



METROPOLITAN lifestyle

LINE

SLANCIO GRINTOSO

Gritty momentum

#linedesign



Le forme minimali e pulite enfatizzano lo stile aggressivo e ricercato di LINE. Lo slancio del corpo e del comando, le linee definite, la disponibilità nelle finiture bianco, nero e cromo lo rendono perfetto per ambienti dal total look grintoso e di tendenza.

Minimal and clean shapes emphasise LINE's aggressive and refined style. The momentum of the body and handle, the clear-cut lines and variety of finishes in white, black and chrome along with the full range of accessories make LINE perfect to decorate living spaces with a gritty and trendy total look.

- 1. Art. 67521NEPR
- 2. Art. DR100NEUB
- 3. Art. 43001CRDA
- 4. Art. SI302NE40



#urbanmood



LAVABO / WASHBASIN
Art. 67520FAPR



DOCCIA / SHOWER
Art. 00888OR55
Art. 12542OR04
Art. 00831OR00
Art. 00867ORNR

LAVABO / WASHBASIN
Art. 12501OR00

ACCESSORI / ACCESSORIES
Art. 11012OR00
Art. 11018OR00
Art. 11007OR50
Art. 11001OR00
Art. 04042OR00

VASCA / BATHTUB
Art. 12535OR0D



SPECIAL THANKS TO

Tecnografica
italian wallpaper

www.tecnografica.net

T·MIX T·LEVA LATERALE

DESIGN CENTER DIRECTED BY
ANTONIO BONGIO



CREATIVE DIALOGUE

T·SQUARE

DESIGN CENTER DIRECTED BY
ANTONIO BONGIO



ECLECTIC PROFILE

REEEF

DESIGN CENTER DIRECTED BY
ANTONIO BONGIO

#SIMPLYBEAUTY

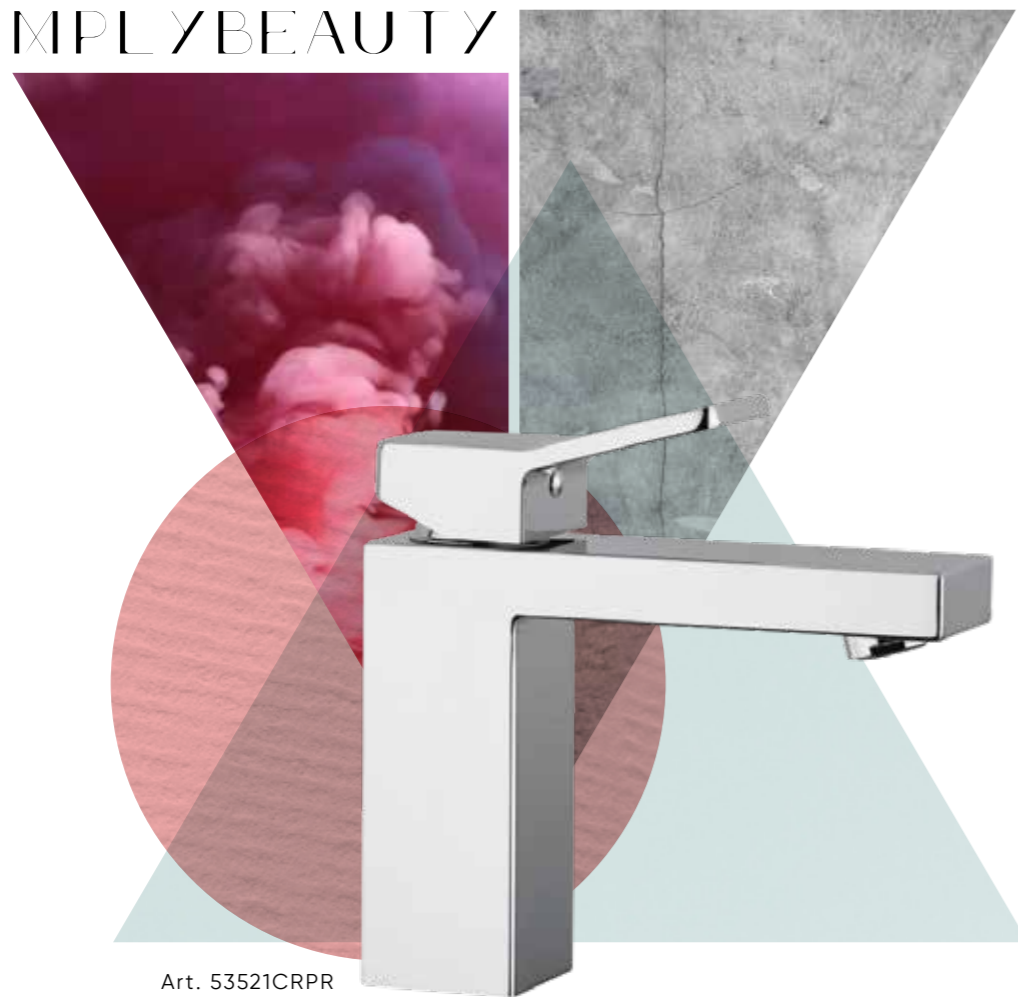

Art. 53521CRPR

REFINED ELEGANCE

PI7

DESIGN CENTER DIRECTED BY
ANTONIO BONGIO

#PURE
ESSENCE



Art.07521CRPR

FREEDOM SENSATION



SWITCH20

DESIGN BY FEDERICO ROSSI

Erogatore cromatico con luce LED
LED dynamo system

- COLD
- HOT

Erogatore con luce LED alimentata con dinamo
(non occorre connessione elettrica)
L'acqua erogata cambia colore (dal blu al rosso)
in funzione della temperatura.

Handshower with LED with dynamo working without
any battery and /or power connection.
The color of the water changes (from blue to red)
according to the temperature of the water itself.

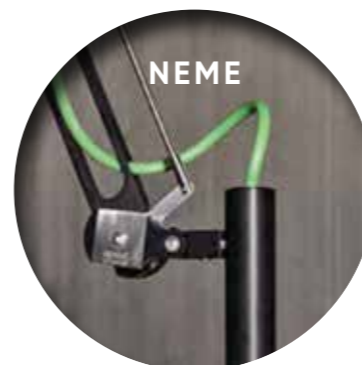
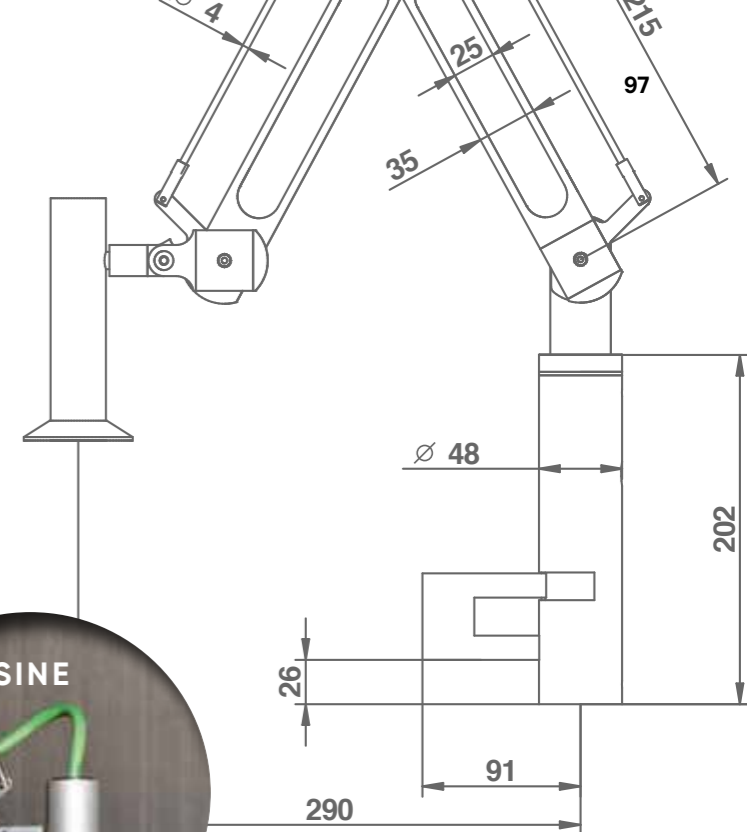

NEME
NERO OPACO/VERDE
MATT BLACK/GREEN
SW580NEME

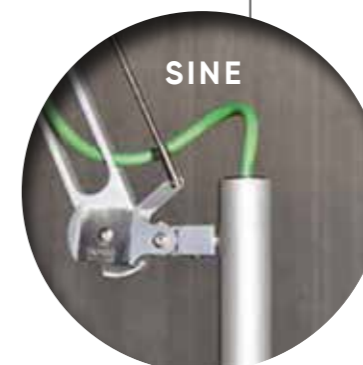

SINE
SILVER/VERDE
SILVER/GREEN
SW580SIME

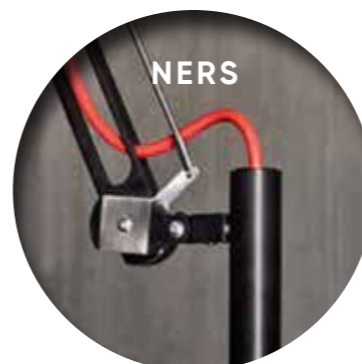

NERS
NERO OPACO/ROSSO
MATT BLACK/RED
SW580NERS



SIRS
SILVER/ROSSO
SILVER/RED
SW580SIRS

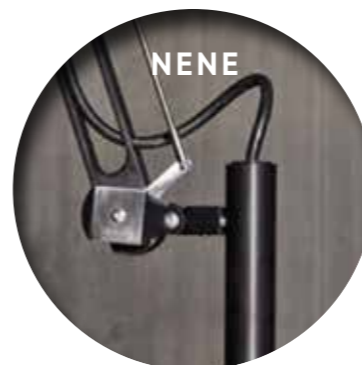

NENE
NERO OPACO/NERO
MATT BLACK/BLACK
SW580NENE



SINE
SILVER/NERO
SILVER/BLACK
SW580SINE

#TECNOARTIGIANATO



Art. SW580SIRS



Art. 07481CRPR



Art. 70590AS00



Art. 70180AS00

WELLNESS



COLONNA DOCCIA
 / SHOWER COLUMN
 Art. 32131BIRS



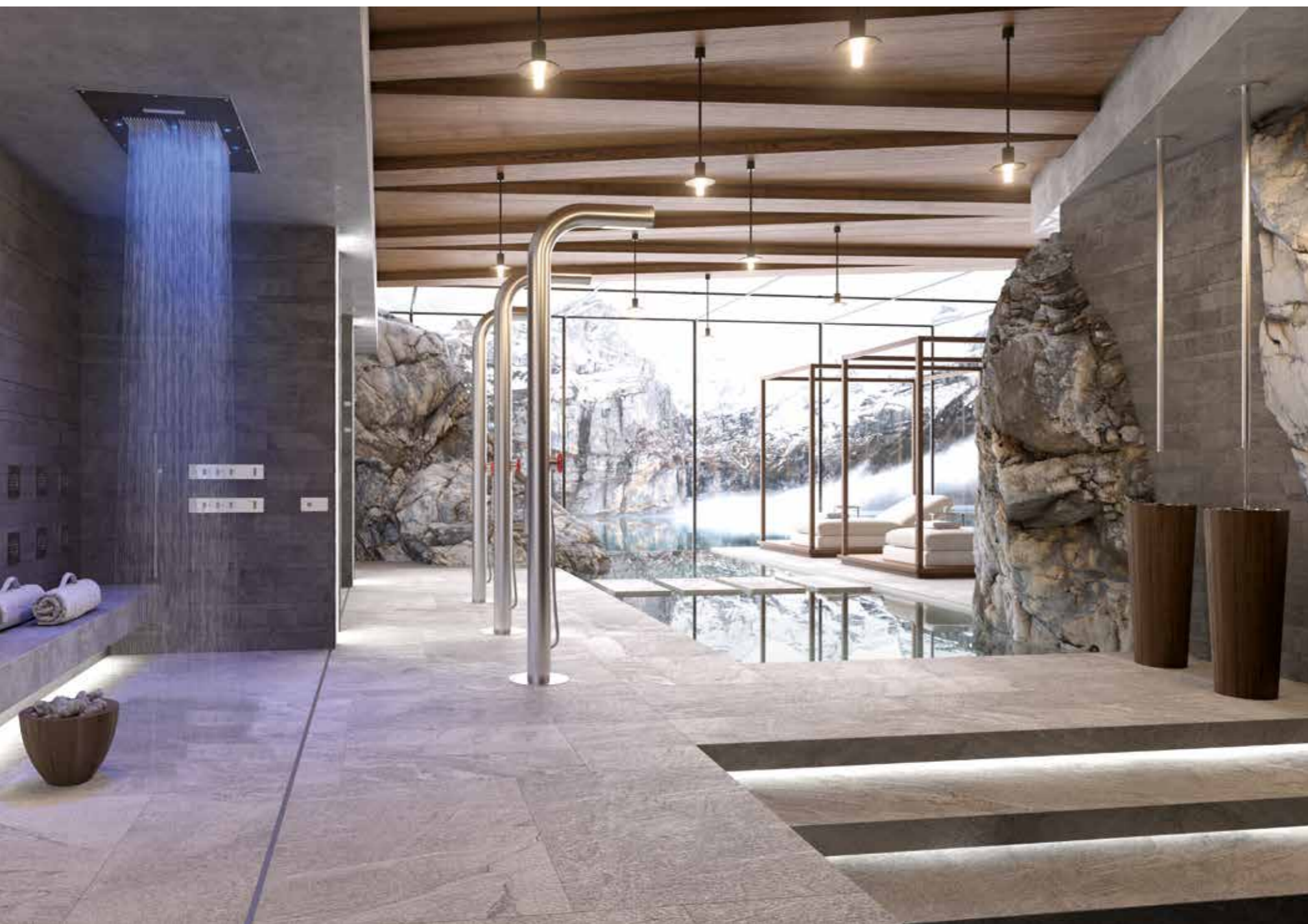

LAVABO
WASHBASIN

Art. 70977/M
Time2020 Collection
Bocca a soffitto
Ceiling spot

Art. S1006TE
Lavabo in teak
Teak free standing washbasin

COLONNA DOCCIA
SHOWER COLUMN

Art. 32131ASRS
Colonna doccia in acciaio 316
316 stainless steel shower column

DOCCIA CROMOTERAPIA
CHROMOTHERAPY SHOWER

Art. 888CRC8
Soffione cromoterapia
multifunzione
Multifunctional chromotherapy
ceiling shower

2x Art. 43542CR03
Termostatico multifunzione
Multifunctional thermostatic

6x Art. 00867CRNO
Bodyjet

Art. 00830CR0EPR
Duplex





Art. 325557CRRDPR

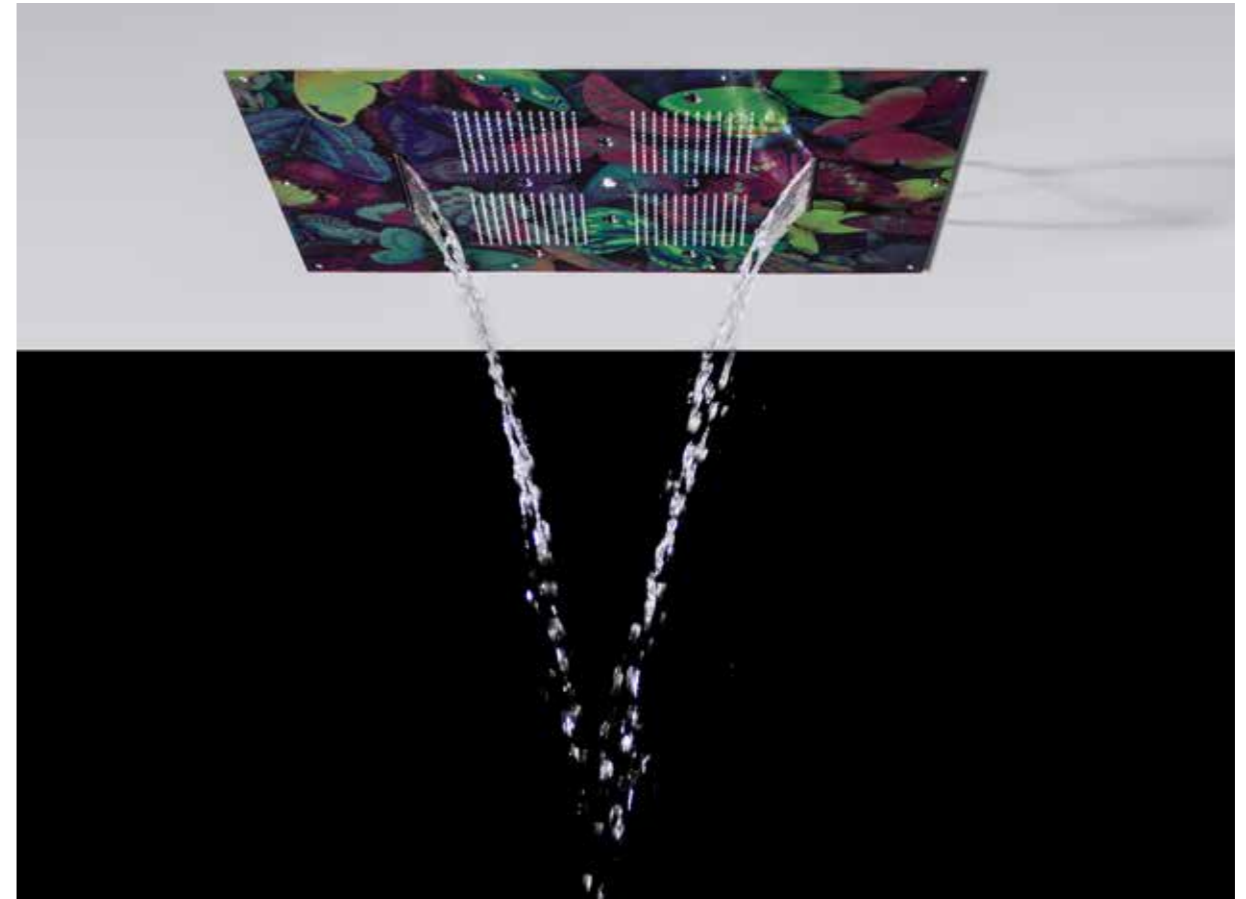

Art. 00888TTC813



Art. 00888CR64



Art. 00879CR00 + 00801CR20



Art. 40554OPOR + Art. 404980POR
Art. 8670POR + Art. 7900PPR

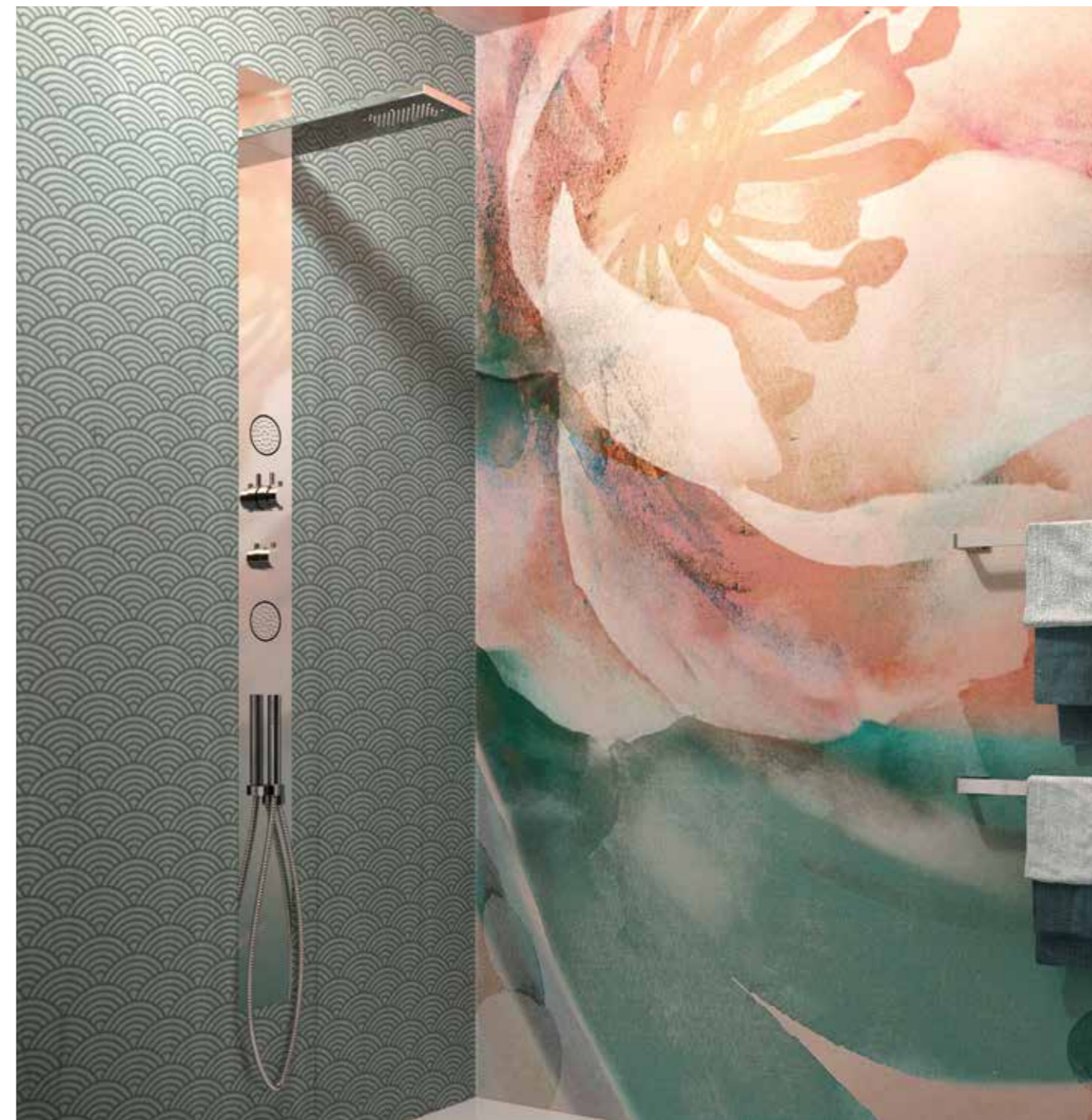

Art. 47132CR00



Art. SW880



Art. 14889NE00

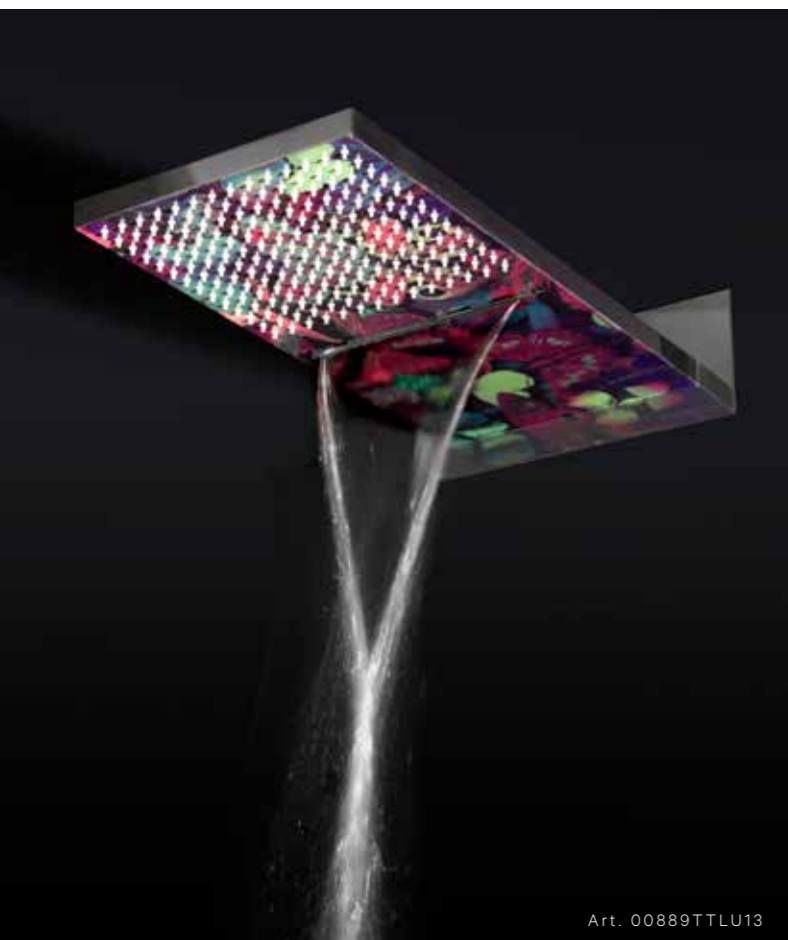

Art. 00889TTLU13



Art. 60804CR40 + 60960CR88 - Art. 60804CR4 + 60961CR88

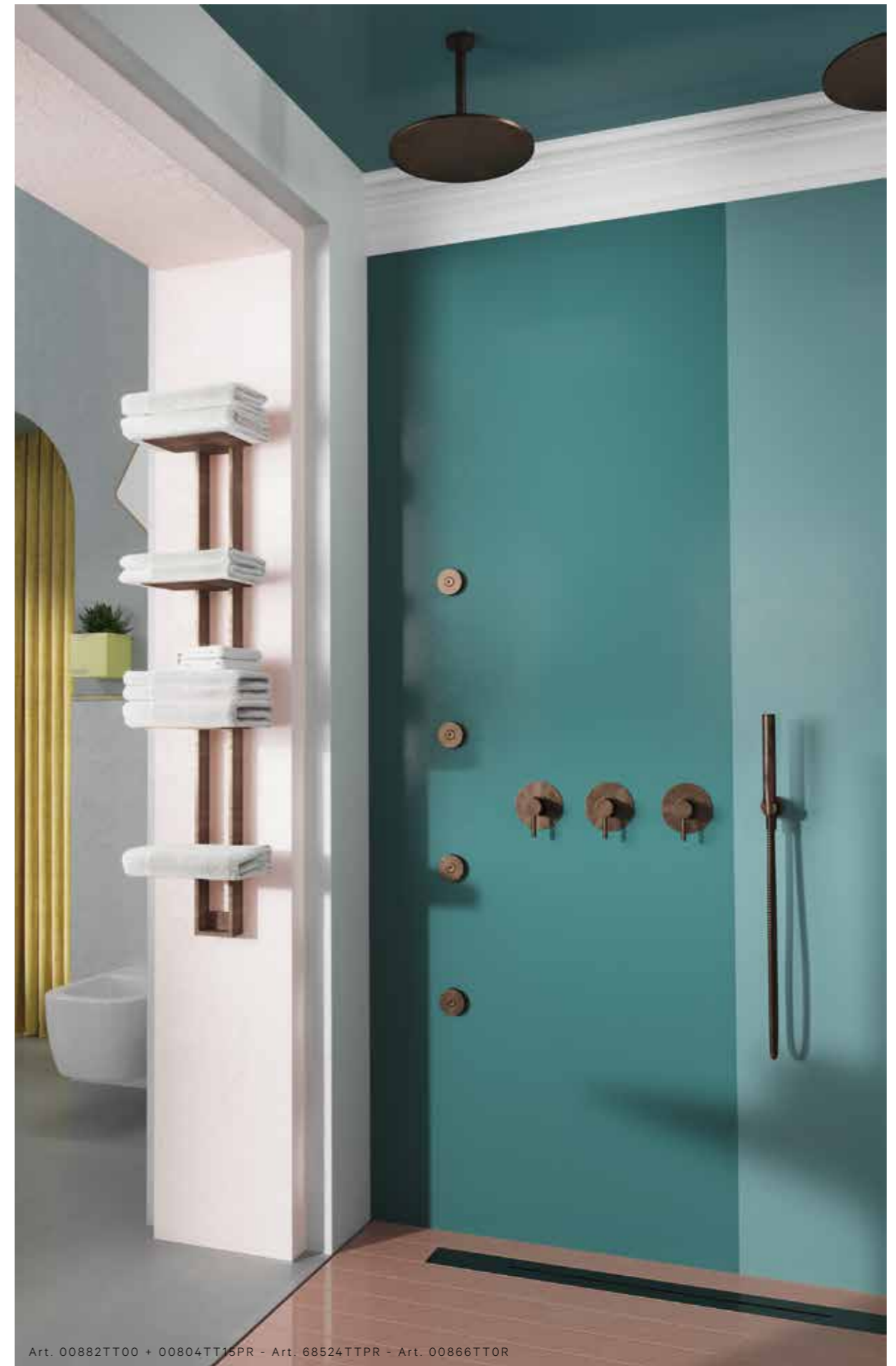

Art. 00882TT00 + 00804TT16PR - Art. 68524TTPR - Art. 00866TT0R

ELETRONICI

Electronics



Art. 00977CREL

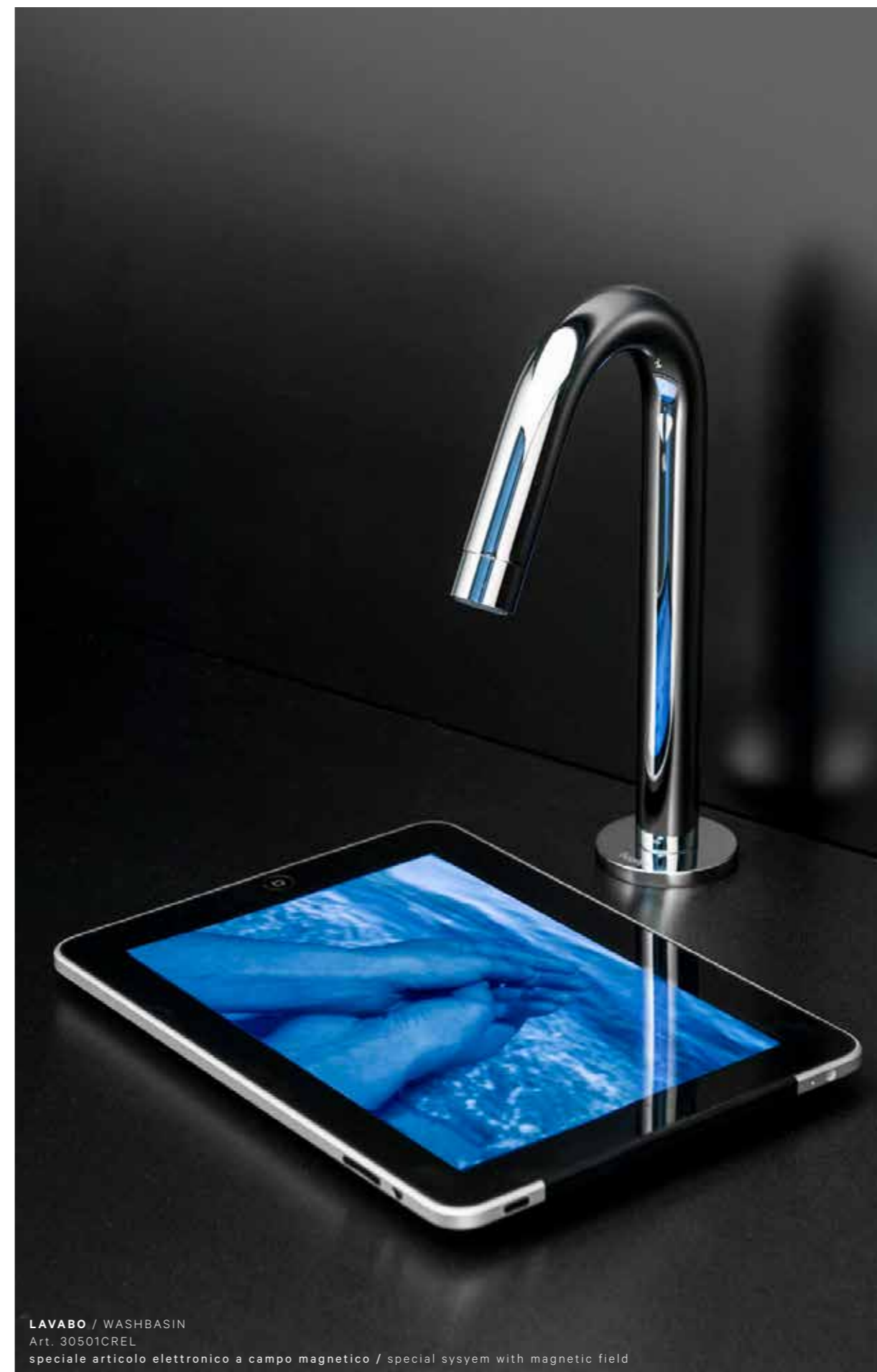

LAVABO / WASHBASIN
 Art. 30501CREL
 speciale articolo elettronico a campo magnetico / special syssem with magnetic field



BOCCHE
Spouts



ACCESSORI

Accessories

Art. 01007OR40



Art. 02004CO00



Art. 70027AS00



Art. 11012 - Art. 11018



Art. 041010A00



Art. 15015FA00

UNI EN ISO 9001

Certificato

Norma: **ISO 9001:2015**

N° certificato: 39 00 0460603

TÜV Rheinland Italia S.r.l. certifica:

Titolare del certificato: **Mario Bongio S.r.l.**

Via A. Moro, 2
28017 San Maurizio d'Opaglio (NO)
Italia

Campo di applicazione: Progettazione e produzione di rubinetteria sanitaria.

Settore IAF: 18

Mediante un audit è stata conseguita la dimostrazione che le prescrizioni della norma ISO 9001:2015 sono soddisfatte.

La data di scadenza per tutte le prossime verifiche è 17.12.

Validità: Questo certificato è valido dal 29.12.2016 al 28.12.2019.
Prima certificazione 2006.

03.03.2017

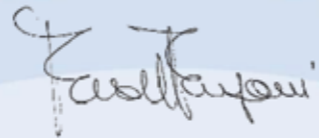

TÜV Rheinland Italia S.r.l., Via E. Mattei, 3
I - 20010 Pogliano Milanese (MI)

www.tuvitalia.com



SGQ N° 083A SGA N° 052D
Membro degli Accordi di Mutuo
Riconoscimento EA, IAF e ILAC
Signatory of EA, IAF and ILAC
Mutual Recognition Agreement





Mario Bongio S.r.l.

via Aldo Moro, 2

28017 - San Maurizio d'Opaglio (NO)

Italia

T: +39 0322 96 72 48

F: +39 0322 95 00 12

info@bongio.it

www.bongio.com